

SONY®

4-288-916-12(1)

NEX-5N

Interchangeable Lens Digital Camera

Instruction Manual

E-mount

Preparing the camera

Mastering the basic
operation

Using the recording
functions

Using the playback
functions

Checking the functions
available

Importing images to the
computer

Others

Additional information on this product and answers to frequently asked questions can be found at our Customer Support Website.

<http://www.sony.net/>

Printed using VOC (Volatile Organic Compound)-free vegetable oil based ink.



4288916120

©2011 Sony Corporation Printed in Thailand

α

NEX-5N

English

Owner's Record

The model and serial numbers are located on the bottom. Record the serial number in the space provided below. Refer to these numbers whenever you call upon your Sony dealer regarding this product.

Model No. NEX-5N

Serial No. _____

WARNING

To reduce fire or shock hazard, do not expose the unit to rain or moisture.

IMPORTANT SAFETY INSTRUCTIONS -SAVE THESE INSTRUCTIONS DANGER -TO REDUCE THE RISK OF FIRE OR ELECTRIC SHOCK, CAREFULLY FOLLOW THESE INSTRUCTIONS

If the shape of the plug does not fit the power outlet, use an attachment plug adaptor of the proper configuration for the power outlet.

CAUTION

Battery pack

If the battery pack is mishandled, the battery pack can burst, cause a fire or even chemical burns. Observe the following cautions.

- Do not disassemble.
- Do not crush and do not expose the battery pack to any shock or force such as hammering, dropping or stepping on it.
- Do not short circuit and do not allow metal objects to come into contact with the battery terminals.
- Do not expose to high temperature above 60°C (140°F) such as in direct sunlight or in a car parked in the sun.
- Do not incinerate or dispose of in fire.
- Do not handle damaged or leaking lithium ion batteries.

- Be sure to charge the battery pack using a genuine Sony battery charger or a device that can charge the battery pack.
- Keep the battery pack out of the reach of small children.
- Keep the battery pack dry.
- Replace only with the same or equivalent type recommended by Sony.
- Dispose of used battery packs promptly as described in the instructions.

| Battery charger

Even if the CHARGE lamp is not lit, the battery charger is not disconnected from the AC power source (mains) as long as it is connected to the wall outlet (wall socket). If some trouble occurs while using the battery charger, immediately shut off the power by disconnecting the plug from the wall outlet (wall socket).

The power cord (mains lead), if supplied, is designed specifically for use with this camera only, and should not be used with other electrical equipment.

For Customers in the U.S.A. and Canada

| RECYCLING LITHIUM-ION BATTERIES

Lithium-Ion batteries are recyclable.

You can help preserve our environment by returning your used rechargeable batteries to the collection and recycling location nearest you.



For more information regarding recycling of rechargeable batteries, call toll free 1-800-822-8837, or visit <http://www.rbrcc.org/>

Caution: Do not handle damaged or leaking Lithium-Ion batteries.

| Battery pack and lens

This device complies with Part 15 of the FCC Rules. Operation is subject to the following two conditions:

(1) This device may not cause harmful interference, and (2) this device must accept any interference received, including interference that may cause undesired operation.

This Class B digital apparatus complies with Canadian ICES-003.

For Customers in the U.S.A.

UL is an internationally recognized safety organization.
The UL Mark on the product means it has been UL Listed.

If you have any questions about this product, you may call:

Sony Customer Information Center
1-800-222-SONY (7669)

The number below is for the FCC related matters only.

Regulatory Information

Declaration of Conformity

Trade Name: SONY

Model No.: NEX-5N

Responsible Party: Sony Electronics Inc.

Address: 16530 Via Esprillo, San Diego, CA 92127 U.S.A.

Telephone No.: 858-942-2230

This device complies with Part 15 of the FCC Rules. Operation is subject to the following two conditions: (1) This device may not cause harmful interference, and (2) this device must accept any interference received, including interference that may cause undesired operation.

CAUTION

You are cautioned that any changes or modifications not expressly approved in this manual could void your authority to operate this equipment.

| Note:

This equipment has been tested and found to comply with the limits for a Class B digital device, pursuant to Part 15 of the FCC Rules.

These limits are designed to provide reasonable protection against harmful interference in a residential installation. This equipment generates, uses, and can radiate radio frequency energy and, if not installed and used in accordance with the instructions, may cause harmful interference to radio communications. However, there is no guarantee that interference will not occur in a particular installation. If this equipment does cause harmful interference to radio or television reception, which can be determined by turning the equipment off and on, the user is encouraged to try to correct the interference by one or more of the following measures:

- Reorient or relocate the receiving antenna.
- Increase the separation between the equipment and receiver.
- Connect the equipment into an outlet on a circuit different from that to which the receiver is connected.
- Consult the dealer or an experienced radio/TV technician for help.

The supplied interface cable must be used with the equipment in order to comply with the limits for a digital device pursuant to Subpart B of Part 15 of FCC Rules.

For Customers in Europe

| Notice for the customers in the countries applying EU Directives

The manufacturer of this product is Sony Corporation, 1-7-1 Konan Minato-ku Tokyo, 108-0075 Japan. The Authorized Representative for EMC and product safety is Sony Deutschland GmbH, Hedelfinger Strasse 61, 70327 Stuttgart, Germany. For any service or guarantee matters please refer to the addresses given in separate service or guarantee documents.

This product has been tested and found compliant with the limits set out in the EMC Directive for using connection cables shorter than 3 meters (9.8 feet).

| Attention

The electromagnetic fields at the specific frequencies may influence the picture and sound of this unit.

| Notice

If static electricity or electromagnetism causes data transfer to discontinue midway (fail), restart the application or disconnect and connect the communication cable (USB, etc.) again.

Disposal of Old Electrical & Electronic Equipment (Applicable in the European Union and other European countries with separate collection systems)



This symbol on the product or on its packaging indicates that this product shall not be treated as household waste. Instead it shall be handed over to the applicable collection point for the recycling of electrical and electronic equipment. By ensuring this product is disposed of correctly, you will help prevent potential negative consequences for the environment and human health, which could otherwise be caused by inappropriate waste handling of this product. The recycling of materials will help to conserve natural resources. For more detailed information about recycling of this product,

please contact your local Civic Office, your household waste disposal service or the shop where you purchased the product.

Disposal of waste batteries (applicable in the European Union and other European countries with separate collection systems)



This symbol on the battery or on the packaging indicates that the battery provided with this product shall not be treated as household waste. On certain batteries this symbol might be used in combination with a chemical symbol. The chemical symbols for mercury (Hg) or lead (Pb) are added if the battery contains more than 0.0005% mercury or 0.004% lead. By ensuring these batteries are disposed of correctly, you will help prevent

potentially negative consequences for the environment and human health which could otherwise be caused by inappropriate waste handling of the battery. The recycling of the materials will help to conserve natural resources.



In case of products that for safety, performance or data integrity reasons require a permanent connection with an incorporated battery, this battery should be replaced by qualified service staff only. To ensure that the battery will be treated properly, hand over the product at end-of-life to the applicable collection point for the recycling of electrical and electronic equipment.

For all other batteries, please view the section on how to remove the battery from the product safely.

Hand the battery over to the applicable collection point for the recycling of waste batteries. For more detailed information about recycling of this product or battery, please contact your local Civic Office, your household waste disposal service or the shop where you purchased the product.

Notice for customers in the United Kingdom

A moulded plug complying with BS 1363 is fitted to this equipment for your safety and convenience.

Should the fuse in the plug supplied need to be replaced, a fuse of the same rating as the supplied one and approved by ASTA or BSI to BS 1362, (i.e., marked with an  or  mark) must be used.

If the plug supplied with this equipment has a detachable fuse cover, be sure to attach the fuse cover after you change the fuse. Never use the plug without the fuse cover. If you should lose the fuse cover, please contact your nearest Sony service station.

Table of contents

Preparing the camera

Checking the supplied items	9
Identifying parts	10
Charging the battery pack	15
Inserting the charged battery pack	17
Attaching/removing the lens	19
Inserting a memory card (sold separately)	21
Attaching the flash	23
Turning on the camera and setting up the date	25

Mastering the basic operation

Shooting still images	27
Recording movies	29
Playing back images	30
Deleting images	32
Operating the camera	33
Using the guide function of the camera	37

Using the recording functions

Setting the function using Photo Creativity	38
Adjusting the brightness of still images (Exposure compensation)	41
Using the self-timer	41
Shooting still images continuously	42
Changing the screen display (DISP)	43
Shooting with various drive modes	44
Selecting the flash mode	48
Selecting the image size/record setting	49

Using the playback functions

Enlarging the playback image (Enlarge Image)	52
Displaying the image list	53
Viewing images on a TV	54

Checking the functions available

Menu list	55
Functions available for each shooting mode	63
Flash modes available.....	64

Importing images to the computer

Installing the software.....	65
What you can do with the supplied software	67
Creating a disc of movies.....	68

Others

Checking the number of recordable images	70
List of icons on the LCD monitor	73
Learning more about the camera (α Handbook)	77
Troubleshooting.....	78
Precautions.....	82
Specifications	87
Index.....	92

This manual covers several models supplied with different lenses.

The model name varies depending on the supplied lens. The available model varies depending on the countries/regions.

Model name	Lens
NEX-5N	None
NEX-5ND	E18 – 55 mm and E16 mm
NEX-5NK	E18 – 55 mm
NEX-5NY	E55 – 210 mm and E18 – 55 mm

Checking the supplied items

First check the model name of your camera (page 8). The accessories supplied differ depending on the model.

The number in parentheses indicates the number of pieces.

Common accessories

- Camera (1)
- Battery charger BC-VW1 (1)

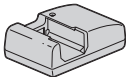

- Power cord (mains lead) (1) (not supplied in the U.S.A. and Canada)



- Rechargeable battery pack NP-FW50 (1)



- USB cable (1)



- Shoulder strap (1)

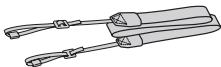

- Flash HVL-F7S (1)/Flash case (1)

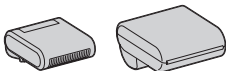

- CD-ROM (1)
 - Application Software for α camera
 - α Handbook
- Instruction Manual (This manual) (1)

NEX-5N

- Body cap (1) (attached to the camera)

NEX-5ND

- E16 mm single focus lens (1)/Front lens cap (1)/Rear lens cap (1)
- E18 – 55 mm zoom lens (1)/Front lens cap (1) (attached to the camera)/Lens hood (1)

NEX-5NK

- E18 – 55 mm zoom lens (1)/Front lens cap (1) (attached to the camera)/Lens hood (1)

NEX-5NY

- E18 – 55 mm zoom lens (1)/Front lens cap (1) (attached to the camera)/Lens hood (1)
- E55 – 210 mm zoom lens (1)/Front lens cap (1)/Rear lens cap (1)/Lens hood (1)

Identifying parts

See the pages in parentheses for details of operation.

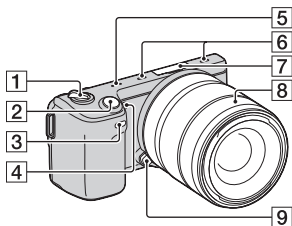

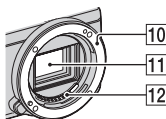

When the lens is removed

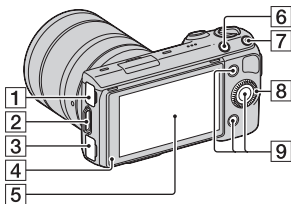

- 1** ON/OFF (Power) switch (25)
- 2** Shutter button (28)
- 3** Remote sensor
- 4** AF illuminator/Self-timer lamp/
Smile Shutter lamp
- 5** Speaker
- 6** Microphone ¹⁾
- 7** Smart Accessory Terminal 2 ²⁾
(23)
- 8** Lens (19)
- 9** Lens release button (20)
- 10** Mount
- 11** Image sensor ³⁾
- 12** Lens contacts ³⁾

- ¹⁾ Do not cover this part during movie recording.
- ²⁾ Accessories for the Smart Accessory Terminal can be also attached.
- ³⁾ Do not touch this part directly.



- 1**  (USB) terminal
- 2** Hook for shoulder strap
Attaching the shoulder strap is recommended not to drop the camera.

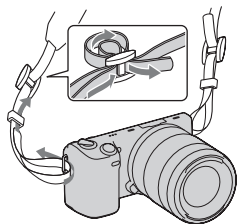

- 3** HDMI terminal (54)
- 4** Light sensor
- 5** LCD monitor/Touch panel (34)
The tilting LCD monitor of the camera allows flexible shooting positions.

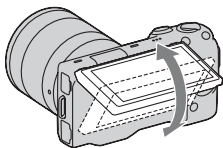

- 6**  (Playback) button (30)
- 7** MOVIE button (29)
- 8** Control wheel (33)
- 9** Soft keys (34)

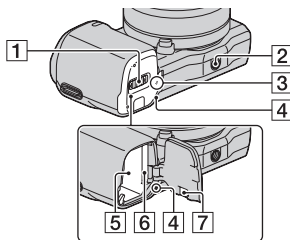

- 1** Battery/memory card cover (17, 21)
- 2** Tripod receptacle
 - Use a tripod with a screw length of less than 5.5 mm (7/32 inch). You will be unable to firmly secure the camera to tripods having screws longer than 5.5 mm (7/32 inch), and may damage the camera.
- 3** ⊖ Image sensor position mark
- 4** Access lamp (22)
- 5** Battery compartment (17)
- 6** Memory card insertion slot (21)
- 7** Connection plate cover
For using the AC-PW20 AC Adaptor (sold separately)

Flash HVL-F7S

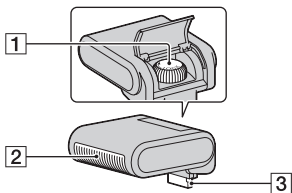

- 1** Screw
- 2** Flash*
- 3** Connector*

* Do not touch this part directly.
If it is dirty, wipe it off with a soft clean cloth.

■ Lens

See page 89 on the specifications of the lenses.

E18 – 55 mm F3.5-5.6 OSS (supplied with NEX-5ND/ 5NK/5NY)

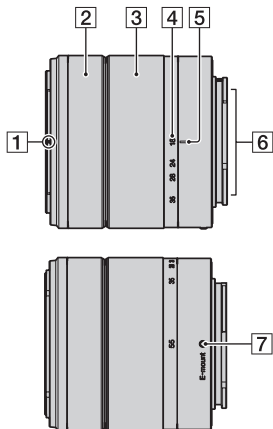

- 1 Hood index
- 2 Focusing ring
- 3 Zooming ring
- 4 Focal-length scale
- 5 Focal-length index
- 6 Lens contacts*
- 7 Mounting index

* Do not touch this part directly.

E16 mm F2.8 (supplied with NEX-5ND)

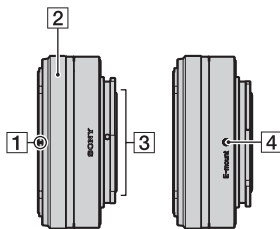

- 1 Converter index*
- 2 Focusing ring
- 3 Lens contacts**
- 4 Mounting index

* A converter is sold separately.

** Do not touch this part directly.

E55 – 210 mm F4.5-6.3 OSS (supplied with NEX-5NY)

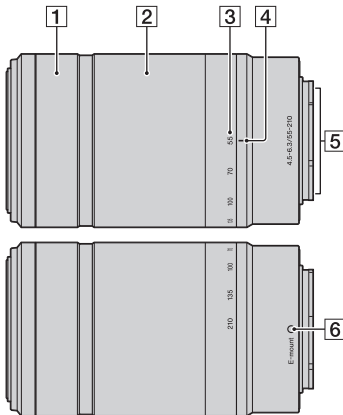

- 1 Focusing ring
- 2 Zooming ring
- 3 Focal-length scale
- 4 Focal-length index
- 5 Lens contacts*
- 6 Mounting index

* Do not touch this part directly.

Charging the battery pack

When using the camera for the first time, be sure to charge the NP-FW50 “InfoLITHIUM” battery pack (supplied).

The “InfoLITHIUM” battery pack can be charged even when it has not been fully depleted. It can also be used when it has not been fully charged.

1 Insert the battery pack onto the battery charger.

- Push the battery pack until it clicks.

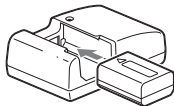

2 Connect the battery charger to the wall outlet (wall socket).

Estimated charging time	250 minutes
-------------------------	-------------

- Time required to charge a fully depleted battery pack at a temperature of 25 °C (77 °F).
- The CHARGE lamp turns off when charging is finished.

For the U.S.A and Canada

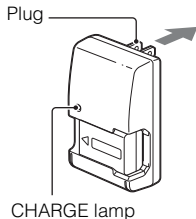

For countries/regions other than the U.S.A. and Canada

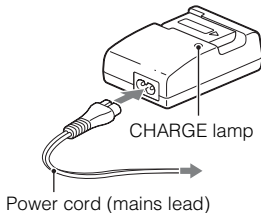

Notes

- The charging time differs depending on the remaining capacity of the battery pack or charging conditions.
- We recommend charging the battery pack in an ambient temperature of between 10 °C and 30 °C (50 °F and 86 °F). You may not be able to efficiently charge the battery pack outside of this temperature range.
- Connect the battery charger to the nearest wall outlet (wall socket).
- The CHARGE lamp may flash quickly when the battery pack is used for the first time, or the battery pack has not been used for a long time. In such cases, remove the battery pack from the charger and re-attach it, then charge the battery pack.
- Do not try to charge the battery pack again right after it has been charged, or when it has not been used after being charged. Doing so will affect the performance of the battery pack.

**Using your camera abroad — Power source**

You can use your camera and battery charger, and the AC-PW20 AC Adaptor (sold separately) in any countries/regions where the power supply is within 100 V to 240 V AC, 50 Hz/60 Hz.

An electronic voltage transformer is unnecessary and its use may cause a malfunction.

Inserting the charged battery pack

- 1 While sliding the cover open lever, open the cover.

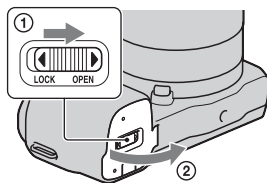

- 2 Firmly insert the battery pack all the way while pressing the lock lever with the tip of the battery.

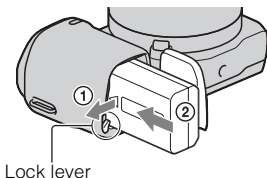

- 3 Close the cover.

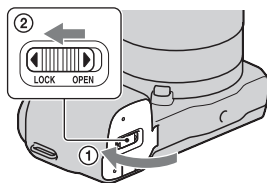

■ Checking the remaining battery level

Check the level with the following indicators and percent figures displayed on the LCD monitor.

Battery level						"Battery exhausted."
	High Low					You cannot shoot any more image.

Note

- The displayed level may not be correct under certain circumstances.

**What is an “InfoLITHIUM” battery pack?**

An “InfoLITHIUM” battery pack is a lithium-ion battery pack that has functions for exchanging information related to operating conditions with your camera.

Using the “InfoLITHIUM” battery pack, the remaining battery time in percent figures is displayed according to the operating conditions of your camera.

Removing the battery pack

Turn off the camera, make sure that the access lamp is not lit, slide the lock lever in the direction of the arrow, and pull out the battery pack. Be careful not to drop the battery pack.

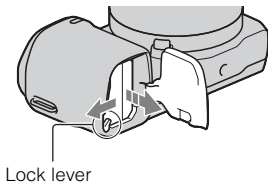

Attaching/removing the lens

Set the power switch of the camera to OFF before you attach or remove the lens.

- 1 If the cap or the packaging lid is attached, remove it from the camera or the lens.

- Quickly change the lens somewhere away from dusty locations so as to keep dust or debris from getting inside the camera.

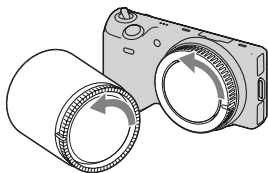

- 2 Mount the lens by aligning the white index marks on the lens and the camera.

- Hold the camera's face downward to prevent the dust from entering into the camera.

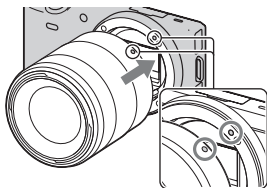

White index marks

- 3 While pushing the lens lightly toward the camera, turn the lens clockwise until it clicks into the locked position.

- Be sure to put the lens on straight.

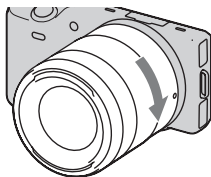

Notes

- When attaching a lens, do not press the lens release button.
- Do not use force when attaching a lens.
- The Mount Adaptor (sold separately) is required to use an A-mount lens (sold separately). For details, refer to the operating manual supplied with the Mount Adaptor.

■ Removing the lens

- 1 Press the lens release button all the way in and turn the lens counterclockwise until it stops.

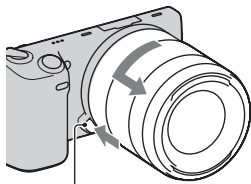

Lens release button

Notes

- When changing the lens, if dust or debris gets inside the camera and adheres to the surface of the image sensor (the part that acts as the film), it may appear as dark spots on the image, depending on the shooting environment. The camera vibrates slightly when it is turned off, due to the anti-dust function, to prevent dust from adhering to the image sensor. However, attach or remove the lens quickly somewhere away from dusty locations.
- Do not leave the camera with the lens removed.
- When you want to use body caps or rear lens caps, please purchase ALC-B1EM (Body cap) or ALC-R1EM (Rear lens cap) (sold separately).

Inserting a memory card (sold separately)

- 1 Open the cover.

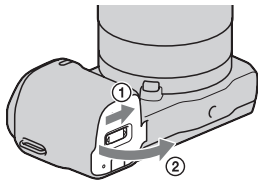

- 2 Insert a memory card.
 - Insert the memory card until it clicks as illustrated.

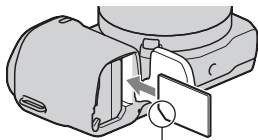

Check on the direction of the notched corner.

- 3 Close the cover.

Memory cards that you can use

You can use following types of memory cards with this camera. However, proper operation cannot be guaranteed for all types of the memory cards.

Usable memory card	Still image	Movie	Term in this manual
“Memory Stick PRO Duo” media	✓	✓ (Mark2)	“Memory Stick PRO Duo” media
“Memory Stick PRO-HG Duo” media	✓	✓	
SD memory card	✓	✓ (Class 4 or more)	SD card
SDHC memory card	✓	✓ (Class 4 or more)	
SDXC memory card	✓	✓ (Class 4 or more)	

You cannot use MultiMediaCard.

Note

- Images recorded on an SDXC memory card cannot be imported to or played on computers or AV devices that are not compatible with exFAT. Make sure that the device is compatible with exFAT before connecting it to the camera. If you connect your camera to an incompatible device, you may be prompted to format the card. Never format the card in response to this prompt, as doing so will erase all data on the card. (exFAT is the file system used on SDXC memory cards.)

Removing the memory card

Open the cover, make sure that the access lamp is not lit, and push the memory card once.

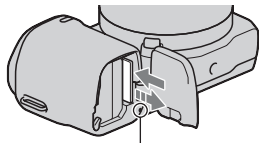

Access lamp

Note

- When the access lamp is lit, do not remove the memory card or the battery pack, or turn off the power. The data may be corrupted.

Attaching the flash

When you want to use a flash during shooting, attach the flash device (supplied).

The flash is enabled when it is raised, and disabled when lowered.

Set the power switch of the camera to OFF before you attach or remove the flash.

- 1 Attach the flash to the Smart Accessory Terminal 2 of the camera.

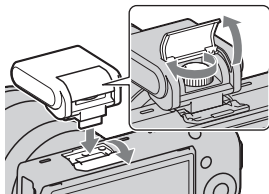

- 2 Fasten the screw to secure the flash.

- 3 To fire the flash, raise the flash first.

- The default setting is [Autoflash]. To change the setting, see page 48.
- Lower the flash when you do not intend to use it.

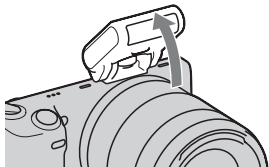

Notes

- The power for the flash is provided from the camera. When the camera is charging the flash,  blinks on the LCD monitor. You cannot press the shutter button when this icon is blinking.
- Plug the flash fully into the accessory terminal of the camera, and fasten the screw securely. Make sure that the flash is attached to the camera securely.



Carrying the flash

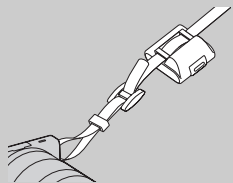

The flash case can be conveniently attached to the shoulder strap.

Put the flash in the case when you are not using it to protect it from harm.

Turning on the camera and setting up the date

When you turn on the camera for the first time, the screen to set date and time appears.

- 1 Set the power switch to ON to turn on the camera.

The screen to set date and time appears.

- To turn off the camera, set the power switch to OFF.

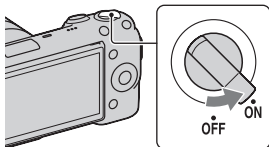

- 2 Press the center of the control wheel. Or, touch OK on the screen.

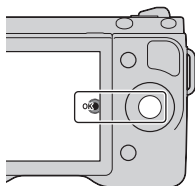

- 3 Select your area by pressing the right or left of the control wheel and press the center.

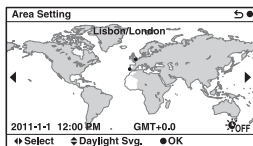

- 4 Press the left or right of the control wheel to select each item, and press the top or bottom, or turn it to select the numeric value.

Daylight Svg.: Turns on or off the daytime saving time setting.

Date Format: Selects the format to display date.

- Midnight is indicated as 12:00 AM, and noon as 12:00 PM.

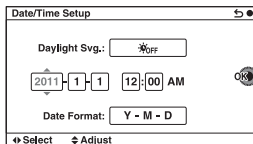

5 Repeat step 4 to set other items, then press the center of the control wheel. Or, touch OK on the screen.

Notes

- You cannot set the date, time and area by touching the screen.
- You cannot superimpose the date on images on this camera. Using “PMB” stored on the CD-ROM (supplied), you can save or print images with date. Refer to “PMB Help” for more details (page 67).

Resetting the date and time/Checking the current clock setting

Select MENU → [Setup] → [Date/Time Setup] (page 33, 61).

Maintaining the date and time setting











This camera has an internal rechargeable battery for maintaining the date and time and other settings regardless of whether the power is on or off, or the battery is installed or not. For details, see page 84.

Shooting still images

In the **i** (Intelligent Auto) mode, the camera analyzes the subject, and allows you to shoot with appropriate settings.

1 Set the power switch to ON to turn on the camera.

2 Point the camera to the subject.

When the camera recognizes the scene, the Scene Recognition icon and guide appear on the LCD monitor:  (Night Scene),  (Tripod Night Scene),  (Night Portrait),  (Backlight),  (Backlight Portrait),  (Portrait),  (Landscape),  (Macro),  (Spotlight),  (Low Brightness), or  (Baby).



Scene Recognition icon and guide

3 When using a zoom lens, turn the zoom ring, then decide on your shot.

- Optical zooming is not available with a single focus lens.

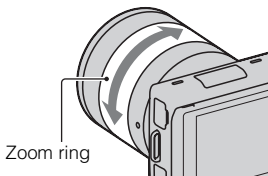

4 Press the shutter button halfway down to focus.

When the focus is confirmed, beeps sound and ● lights up.

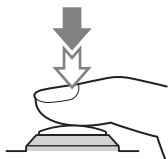

Focus indicator

5 Press the shutter button fully down to shoot.

Recording movies

1 Set the power switch to ON to turn on the camera.

2 Point the camera to the subject.

3 Press the MOVIE button to start recording.

- Focus and brightness are adjusted automatically.
- If you press the shutter button halfway down during recording, you will be able to focus more quickly.

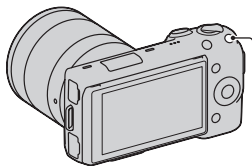

MOVIE button

4 Press the MOVIE button again to stop recording.

Notes

- The sound of the camera and the lens in operation might be recorded while recording a movie. You can disable the sound recording by selecting MENU → [Setup] → [Movie Audio Rec] → [Off] (page 61).
- The continuous recording time of a movie depends on the ambient temperature or the condition of the camera.
- When you are recording continuously for a long time, you may feel that the camera is warm. This is normal. Also, “Camera overheating. Allow it to cool.” may appear. In such cases, turn the camera off and wait until the camera is ready to shoot again.

Playing back images

- 1 Press the  (Playback) button.
The last recorded image is displayed on the LCD monitor.

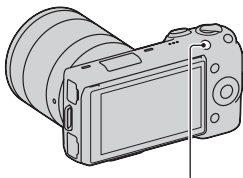

 (Playback) button

■ Selecting the image







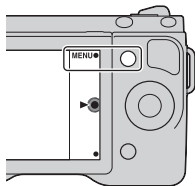

Turn the control wheel. Or, slide the screen left or right.

■ Playing back movies

- 1 Select MENU → [Playback] → [View Mode] → [Folder View(MP4)] or [AVCHD View].
 - To return to still image playback, select [Folder View(Still)].





- 2 Turn the control wheel to select the desired movie, and press the center. Or, touch the desired movie.

During movie playback	Control wheel operation	Touch panel operation
Pause/resume	Press the center.	Touch   .
Fast-forward	Press the right, or turn it clockwise.	Touch  .
Fast-rewind	Press the left, or turn it counterclockwise.	Touch  .
Forward slow playback	Turn clockwise during pause.	Touch   during pause.
Reverse slow playback*	Turn counterclockwise during pause.	Touch   during pause.
Adjust sound volume	Press the bottom → top/bottom.	–

* The movie is played back frame-by-frame.

Deleting images

You can delete the image that is currently displayed.

- 1 Display the desired image, and press  (Delete).
Or, touch  on the screen.

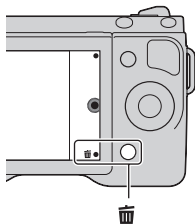

- 2 Press the center of the control wheel. Or, touch OK on the screen.
 - Select  to quit the operation.

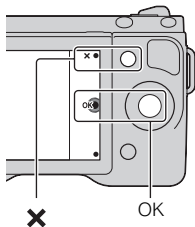



To delete several images

Select MENU → [Playback] → [Delete] to select and delete several images at the same time.

Operating the camera

The control wheel, soft keys and touch panel allow you to use various functions of the camera.

Control wheel

When shooting, DISP (Display Contents),  (Exposure Comp.) and  (Drive Mode) functions are assigned to the control wheel. When playing back, DISP (Display Contents) and  (Image Index) functions are assigned to the control wheel.

When you turn or press the top/bottom/right/left parts of the control wheel following the on-screen display, you can select setting items. Your selection is determined when you press the center of the control wheel.

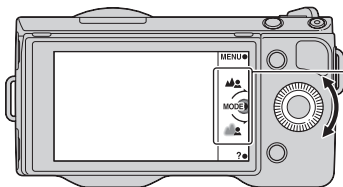

The arrow means you can turn the control wheel.

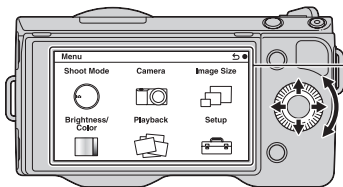

When options are displayed on the screen, you can browse through them by turning or pressing the top/bottom/left/right parts of the control wheel. Press the center to make your choice.

Soft keys

The soft keys have different roles, depending on the context.

The assigned role (function) of each soft key is shown on the screen.

To use the function shown at the upper right corner of the screen, press soft key A. To use the function shown at the lower right corner of the screen, press soft key B. To use the function shown at the center, press the center of the control wheel (soft key C).

In this manual, the soft keys are indicated by the icon or the function shown on the screen.

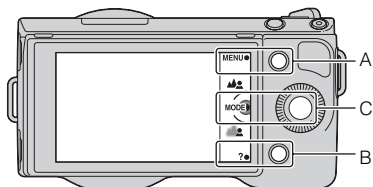

In this case, soft key A works as the MENU (Menu) button, and soft key B as the ? (Shoot Tips) button. Soft key C works as the MODE (Shoot Mode) button.

Touch panel

You can operate the camera intuitively by touching or sliding your finger on the screen. Touch the item on the screen to select it. Slide your finger on the screen to scroll down to hidden items.

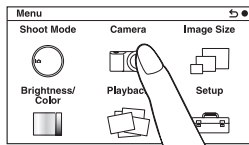



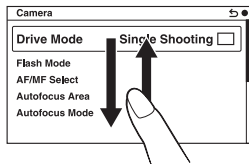



Touch the item to select it.

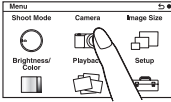

Sliding your finger on the screen will scroll the items. Items on the screen are replaced with ones that were out of view.

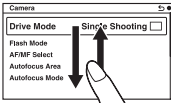
Operations

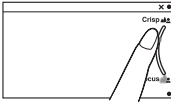
You can select items and make settings in two ways; one is using the control wheel, the other is touching and sliding your finger on the screen (Touch panel).

Operation	Control wheel	Touch panel
To select an item	Turn or press the top/bottom/left/right parts, and then press the center. 	Touch the desired item. 
To display a hidden item	Keep turning or pressing the top/bottom parts until the item scrolls onto the screen. 	Slide your finger up or down on the screen until the item scrolls into view. 
To set a value or adjust the defocusing level	Turn it. 	Slide the indicator with your finger. 
To play the next or the previous image	Turn it or press the left/right parts. 	Slide your finger left or right on the playback screen. 

Notes

- You can perform most operations with both the control wheel/soft keys and the touch panel. However, some operations can be done only with one or the other.
- Avoid the followings:
 - Using a pointed object, such as a pencil, ball-point pen, or the tip of a finger nail.
 - Holding the camera by touching the screen.
- The touch panel may not react when you attempt to operate it with gloves on.

Using the guide function of the camera

The camera provides various “Help Guides” which explain the functions, and “Shooting Tips” which introduce tips for better shooting. Use these guides to make better use of the camera.

■ Help Guides

The camera displays the Help Guide to explain the selected function, when you change the setting, etc.

You can hide the Help Guides by selecting MENU → [Setup] → [Help Guide Display] → [Off].

■ Shooting tips

The camera displays the shooting tips in accordance with the shooting mode selected.

- ① When ? is displayed at the right bottom corner of the screen, press the button at the right bottom (page 34). Or, touch ? on the screen.

A list of shooting tips in accordance with the current subject appears automatically.

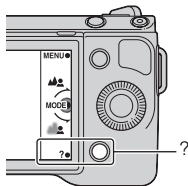

- ② Select the desired shooting tip by pressing the top or bottom of the control wheel, then press the center.
 - Press the right or left of the control wheel to change the item.
 - Turn the control wheel to scroll the text up and down.



To access all shooting tips

You can search through all shooting tips from the menu.

① MENU → [Camera] → [Shooting Tip List].

② Search for the desired shooting tips.

You can access a tip from the [Table of contents].

Setting the function using Photo Creativity



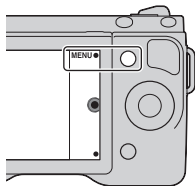

You can operate the camera intuitively using Photo Creativity, since the screen is designed more for intuitive operations than the normal screen. You can shoot a subject with easy operations and obtain creative photos easily.

- 1 Select MENU → [Shoot Mode] →  (Intelligent Auto).

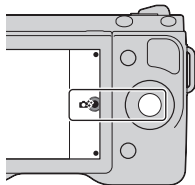

- 2 Press the center of the control wheel.
Or, touch  (Photo Creativity) on the screen.
The Photo Creativity screen appears.



- 3 Select the item you want to adjust by pressing the right/left parts of the control wheel.
Or, touch the desired item on the screen.
 (**Bkground Defocus**): Adjusts the blurring of the background.
 (**Brightness**): Adjusts the brightness.
 (**Color**): Adjusts the color.
 (**Vividness**): Adjusts the vividness.
 (**Picture Effect**): Selects the desired effect filter for shooting.

- 4 Select the desired setting by turning the control wheel.
Or, select the desired setting by touching the indicator or the item on the screen.
 - Repeat Steps 2 – 4 to combine the various functions.

Note

^{GB} 38 • The Photo Creativity function is only available when an E-mount lens is mounted.

■ Defocusing the background easily (Background Defocus Control)

1 Select  (Background Defocus) (page 38).

2 Defocus the background by turning the control wheel.
Or, slide the indicator on the screen.

 : To focus

 : To defocus

- Select AUTO to restore the original status.
- You can record a movie with a value adjusted with the defocusing effect.

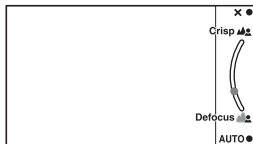

Note

- The defocusing effect may not be noticeable, depending on the distance from the subject or the lens used.



For a better result of Background Defocus

- Move closer to the subject.
- Lengthen the distance between the subject and the background.

Picture Effect

1 Select  (Picture Effect) (page 38).

2 Select the desired effect by turning the control wheel.
Or, slide the screen up or down to select the desired effect.

 **OFF (Off):** Does not use the Picture Effect function.





 **(Toy Camera):** Creates the look of a Toy Camera photo with shaded corners and pronounced colors.

 **(Posterization: Color):** Creates a high contrast, abstract look by heavily emphasizing primary colors.

 **(Posterization: B/W):** Creates a high contrast, abstract look in black and white.

 **(Pop Color):** Creates a vivid look by emphasizing color tones.

 **(Retro Photo):** Creates the look of an aged photo with sepia color tones and faded contrast.

    **(Partial Color):** Creates an image which retains the specified color, but converts others to black and white.

 **(Soft High-key):** Creates an image with the indicated atmosphere: bright, transparent, ethereal, tender, soft.

 **(High Contrast Mono.):** Creates an image with high contrast in black and white.

- You can use more picture effects. Select MENU → [Brightness/Color] → [Picture Effect].
-

Adjusting the brightness of still images (Exposure compensation)

You can adjust the exposure in 1/3 EV steps in a range of -3.0 EV to +3.0 EV.

- 1 Press  (Exposure Comp.) on the control wheel.

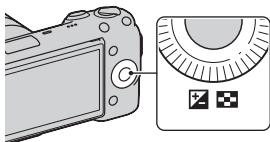



- 2 Turn the control wheel to select the desired value, and press the center.
Or, select the desired value by sliding the indicator on the screen.



When the image is too bright, set [Exposure Comp.] toward -.

When the image is too dark, set [Exposure Comp.] toward +.

Using the self-timer

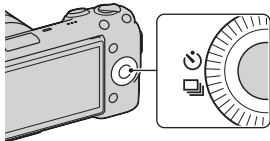
- 1 Press  /  (Drive Mode) on the control wheel.



- 2 Turn the control wheel to select  (Self-timer).
Or, slide the screen up or down to move  (Self-timer) to the center.

3 Press Option, then turn the control wheel to select the desired mode and press the center.

Or, touch Option → desired mode on the screen.

☺₁₀ (Self-timer: 10 Sec): Sets the 10-second delay self-timer. Use this when you want to include yourself in the picture.

When you press the shutter button, the self-timer lamp flashes and beeps until the shutter operates.

☺₂ (Self-timer: 2 Sec): Sets the 2-second delay self-timer. You can prevent blur caused by camera shake that occurs when the shutter button is pressed.

• To cancel the timer, press ☺ / 📷 (Drive Mode) again.



To shoot continuously using the self-timer

Select ☺ (Self-timer(Cont)) from ☺ / 📷 (Drive Mode). The camera starts continuous recording after ten seconds.

Shooting still images continuously

The camera records images continuously while you press and hold down the shutter button.

1 Press ☺ / 📷 (Drive Mode) on the control wheel.

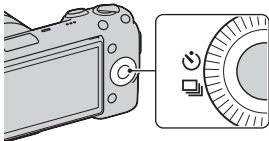

2 Turn the control wheel to select 📷 (Cont. Shooting), and press the center.

Or, slide the screen up or down to move 📷 (Cont. Shooting) to the center, and touch it.



To shoot continuously at a higher speed

Select (Spd Priority Cont.) from / (Drive Mode) to shoot more images continuously (max. 10 images per second). The focus and exposure of the first shot are used for the following shots.

Changing the screen display (DISP)

- 1 Press DISP (Display Contents) on the control wheel.

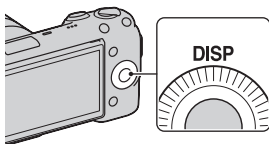

- 2 Press DISP repeatedly to select the desired mode.

During shooting

Graphic Display: Shows basic shooting information. Graphically shows the shutter speed and aperture value, except for when [Shoot Mode] is set to [Sweep Panorama] or [3D Sweep Panorama].

Display All Info.: Shows recording information.

Big Font Size Disp.: Shows only major items in a larger size.

No Disp. Info.: Does not show recording information.

Histogram: Displays the luminance distribution graphically.

For viewfinder: Shows only shooting information on the screen (no image). Select this when you shoot using a viewfinder (sold separately).

During playback

Display Info.: Shows recording information.

Histogram: Displays the luminance distribution graphically, in addition to recording information.

No Disp. Info.: Does not show recording information.

Shooting with various drive modes

- 1 Select MENU → [Shoot Mode].

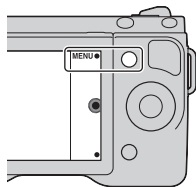

- 2 Turn the control wheel to select the desired mode, and press the center.

Or, slide the screen up or down to move the desired mode to the center, then touch it.

i (Intelligent Auto): The camera evaluates the subject and makes the proper settings.

SCN (Scene Selection): Shoots with preset settings according to the subject or condition.

(⦿) (Anti Motion Blur): Reduces the camera shake when shooting a slightly dark indoor scene or a telephoto.

☞ (Sweep Panorama): Shoots with panoramic size.

3D (3D Sweep Panorama): Shoots 3D panoramic images used for playback on a 3D compatible TV.

M (Manual Exposure): Adjusts the aperture and shutter speed.

S (Shutter Priority): Adjusts the shutter speed to express the movement of the subject.

A (Aperture Priority): Adjusts the range in focus, or defocuses the background.

P (Program Auto): Automatic shooting that allows you to customize settings, except for the exposure (aperture and shutter speed).

■ Scene Selection

1 Select **SCN** (Scene Selection) (page 44).

2 Turn the control wheel to select the desired mode, and press the center.

Or, slide the screen up or down to move the desired mode to the center, then touch it.

 (**Portrait**): Blurs away backgrounds and sharpens the subject. Expresses skin tones softly.

 (**Landscape**): Shoots the entire range of scenery in sharp focus with vivid colors.

 (**Macro**): Shoots close subjects such as flowers, insects, food, or small items.

 (**Sports Action**): Shoots a moving subject at a fast shutter speed so that the subject looks as if it is standing still. The camera shoots images continuously while the shutter button is pressed.

 (**Sunset**): Shoots the red of the sunset beautifully.

 (**Night Portrait**): Shoots portraits in night scenes. Attach and fire the flash.

 (**Night Scene**): Shoots night scenes without losing the dark atmosphere.

 (**Hand-held Twilight**): Shoots night scenes with less noise and blur without using a tripod. A burst of shots are taken, and image processing is applied to reduce subject blur, camera shake, and noise.

■ Anti Motion Blur

This is suitable for indoor shots without using the flash, to reduce the subject blur.



1 Select  (Anti Motion Blur) (page 44).

2 Shoot with the shutter button.

The camera combines six shots at high sensitivity into one still image, so camera shake is reduced while preventing noise.

■ Sweep Panorama/3D Sweep Panorama

While you pan the camera, the camera shoots several images and composes them into one panoramic image.

- 1 Select  (Sweep Panorama) or  (3D Sweep Panorama) (page 44).

- 2 Point the camera at the edge of the subject, then press the shutter button fully down.



This part will not be taken.

- 3 Pan the camera to the end, following the guidance on the LCD monitor.



Guidance bar

Note

- The camera continues shooting during [Sweep Panorama] recording, and the shutter keeps clicking until the end of the shooting.



Playing back scrolling panoramic images

You can scroll panoramic images from the beginning to the end by pressing the center of the control wheel while panoramic images are being displayed. Press it again to pause. You may play/pause by touching  on the screen.





Shows the displayed area of the whole panoramic image.

- Panoramic images are played back with the supplied software “PMB” (page 67).
- Panoramic images shot with other cameras may not be displayed or scrolled correctly.

■ Shutter Priority

You can express the movement of a moving subject in various way by adjusting the shutter speed, for example, at the instant of the movement with high speed shutter, or as a trailing image with low speed shutter.

- 1 Select **S** (Shutter Priority) (page 44).
- 2 Turn the control wheel to select the desired value, and press the center.
Or, touch / on the screen to select the desired value.



Shutter speed





When a faster shutter speed is used, a moving subject such as a running person, cars, and sea spray appears as if they are stopped.



When a slower shutter speed is used, a trailing image of the movement of the subject is captured to make more natural and dynamic image.

■ Aperture Priority

You can adjust the range in focus, or defocuses the background.

- 1 Select **A** (Aperture Priority) (page 44).
- 2 Turn the control wheel to select the desired value, and press the center.
Or, touch / on the screen to select the desired value.
 - You can record a movie with a value adjusted with Aperture Priority.

Selecting the flash mode

1 Attach the flash and raise it (page 23).

2 Select MENU → [Camera] → [Flash Mode].

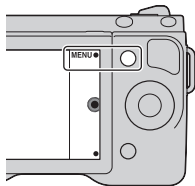



3 Turn the control wheel to select the desired mode, and press the center.
Or, slide the screen up or down to move the desired mode to the center, then touch it.

 **(Flash Off):** Does not fire even if the flash is raised.

 **(Autoflash):** Fires if it is dark or against light.

 **(Fill-flash):** Fires every time you trigger the shutter.

 **(Slow Sync.):** Fires every time you trigger the shutter. Slow sync shooting allows you to shoot a clear image of both the subject and the background.

 **(Rear Sync.):** Fires right before the exposure is completed every time you trigger the shutter. A trailing image of the movement of the subject is captured to make more natural image.

- The selectable items of the flash mode depends on the shooting mode (page 64).
-

Note

- You cannot select [Fill-flash] with [Intelligent Auto].

The flash range

The range of the supplied flash depends on the ISO sensitivity and aperture value.

	F2.8	F3.5	F5.6
ISO100	1 – 2.5 m (3.3 – 8.2 feet)	1 – 2 m (3.3 – 6.6 feet)	1 – 1.25 m (3.3 – 4.1 feet)
ISO3200	5.6 – 14 m (18.3 – 46 feet)	4.5 – 11.2 m (14.7 – 36.7 feet)	2.8 – 7 m (9.1 – 22.9 feet)

Selecting the image size/record setting

The image size determines the size of the image file that is recorded when you take an image.

The larger the image size, the more detail will be reproduced when the image is printed on large format paper. The smaller the image size, the more images can be recorded.

In the case of movies, the larger the bit-rate, the higher the image quality.

- 1 Press MENU.
Or, touch MENU on the screen.

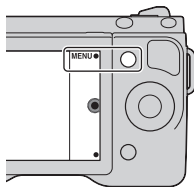



- 2 Select [Image Size] → [Image Size].
For movie recording, select [Image Size] → [Record Setting].

- 3 Select the desired mode.

Still



[Aspect Ratio]: 3:2			Usage guidelines
✓	L:16M	4912 × 3264 pixels	For prints up to A3+ size
	M:8.4M	3568 × 2368 pixels	For prints up to A4 size
	S:4.0M	2448 × 1624 pixels	For prints L/2L size
[Aspect Ratio]: 16:9			Usage guidelines
✓	L:14M	4912 × 2760 pixels	For viewing on a high-definition TV
	M:7.1M	3568 × 2000 pixels	
	S:3.4M	2448 × 1376 pixels	

3D Panorama

	 (16:9)	Shoots images using a size suitable for a high-definition TV. Horizontal: 1920 × 1080
✓	 (Standard)	Shoots images using standard size. Horizontal: 4912 × 1080
	 (Wide)	Shoots images using wide size. Horizontal: 7152 × 1080

Panorama

The image size varies depending on the shooting direction (page 57).

✓	 (Standard)	Shoots images using standard size. Vertical: 3872 × 2160 Horizontal: 8192 × 1856
	 (Wide)	Shoots images using wide size. Vertical: 5536 × 2160 Horizontal: 12416 × 1856

Movie

[File Format]: [AVCHD 60i/60p] or [AVCHD 50i/50p]		Average bit-rate	Recording
	60i 24M(FX)* 50i 24M(FX)**	24 Mbps	Records high image quality movies of 1920 × 1080 (60i/50i).
✓	60i 17M(FH)* 50i 17M(FH)**	17 Mbps	Records standard image quality movies of 1920 × 1080 (60i/50i).
	60p 28M(PS)* 50p 28M(PS)**	28 Mbps	Records highest image quality movies of 1920 × 1080 (60p/50p).
	24p 24M(FX)* 25p 24M(FX)**	24 Mbps	Records high image quality moves of 1920 × 1080 (24p/25p). This produces a cinema-like atmosphere.
	24p 17M(FH)* 25p 17M(FH)**	17 Mbps	Records standard image quality movies of 1920 × 1080 (24p/25p). This produces a cinema-like atmosphere.
[File Format]: MP4		Average bit-rate	Recording
✓	1440×1080 12M	12 Mbps	Records movies of 1440 × 1080.
	VGA 3M	3 Mbps	Records movies of VGA size.

* 1080 60i-compatible device

** 1080 50i-compatible device

Notes



- When you print still images recorded with 16:9 aspect ratio, and panoramic images, both edges may be cut off.
- Movies recorded with the [60p 28M(PS)/50p 28M(PS)] setting in [Record Setting] are converted by “PMB” in order to create a disc. This conversion can take a long time. Also, you cannot create a disc with the original image quality.
- Movies recorded with the [60i 24M(FX)/50i 24M(FX)]/[24p 24M(FX)/25p 24M(FX)] setting in [Record Setting] are converted by “PMB” in order to create an AVCHD disc. This conversion can take a long time. Also, you cannot create a disc with the original image quality. If you want to keep the original image quality, you must store your movies on a Blu-ray Disc.
- To watch 60p/50p or 24p/25p movies on a TV, you need a TV that is compatible with 60p/50p and 24p/25p. If you use a non-compatible TV, the movies are converted to 60i/50i and output to the TV.

Enlarging the playback image (Enlarge Image)

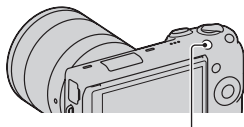

- 1 Press the  (Playback) button to enter the playback mode.

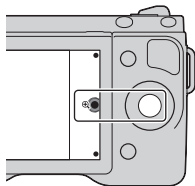

 (Playback) button

- 2 Display the image you want to enlarge, then press  (Enlarge Image) (the center of the control wheel).
Or, touch  on the screen.



- 3 Turn the control wheel to adjust the scaling.
Or, touch  or  on the screen.
-

- 4 Press the top/bottom/right/left of the control wheel to select the portion you want to enlarge.
Or, slide the image to select the portion you want to enlarge.
- When you touch the image, the image is enlarged, centering on the spot you touched.
 - To cancel the operation, select .
-

Displaying the image list

- 1 Press the  (Playback) button to enter the playback mode.

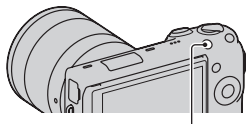

 (Playback) button

- 2 Press  (Image Index) on the control wheel.
Six images are displayed at a time.

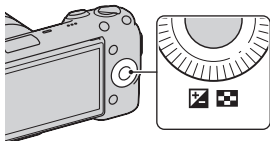

- 3 Turn the control wheel to select an image.

- You can browse images quickly by sliding the screen up or down.
- To return to the single-image screen, select the desired image, and press the center. Or, touch the desired image.



Displaying a desired folder



To select a desired folder, select the bar to the left of the image index screen, then press the top/bottom parts of the control wheel. You may select a folder by touching the bar. You can change the view mode by pressing the center of the bar.

Viewing images on a TV

To view images recorded on the camera on a TV, an HDMI cable (sold separately) and an HD TV equipped with an HDMI connector are required.

- 1 Connect the camera to the TV with an HDMI cable (sold separately).

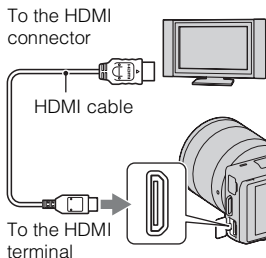

Note

- Use an HDMI mini connector on one end (for the camera), and a plug suitable for connecting your TV on the other end.



Viewing 3D images on a 3D TV

You can view 3D images recorded with the camera on a 3D TV connected to the camera using an HDMI cable (sold separately).

Select MENU → [Playback] → [3D Viewing].

- For details, refer to the operating instructions supplied with the TV.



Using your camera abroad

To view movies shot using this camera on a TV, the camera and TV must use the same color television system.

Menu list

When you press MENU, six menu items; [Shoot Mode], [Camera], [Image Size], [Brightness/Color], [Playback], and [Setup], appear on the screen. You can set various functions in each item. Items that cannot be set in the context are displayed in gray.

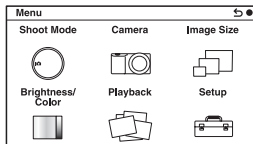

Shoot Mode

Allows you to select a shooting mode, such as exposure mode, panoramic, Scene Selection.

Intelligent Auto	The camera evaluates the subject and makes the proper settings.
Scene Selection	Shoots with preset settings according to the subject or condition. (Portrait/Landscape/Macro/Sports Action/Sunset/ Night Portrait/Night Scene/Hand-held Twilight)
Anti Motion Blur	Reduces the camera shake when shooting a slightly dark indoor scene or a telephoto.
Sweep Panorama	Shoots with panoramic size.
3D Sweep Panorama	Shoots 3D panoramic images used for playback on a 3D compatible TV.
Manual Exposure	Adjusts the aperture and shutter speed.
Shutter Priority	Adjusts the shutter speed to express the movement of the subject.
Aperture Priority	Adjusts the range in focus, or defocuses the background.
Program Auto	Automatic shooting that allows you to customize settings, except for the exposure (shutter speed and aperture).

■ Camera

Allows you to set shooting functions, such as continuous shooting, self-timer, and flash.

Drive Mode	Selects the drive mode, such as continuous shooting, self-timer, or bracket shooting. (Single Shooting/Cont. Shooting/Spd Priority Cont./ Self-timer/Self-timer(Cont)/ Bracket: Cont./Remote Cdr.)
Flash Mode	Selects the method used to fire the flash. (Flash Off/Autoflash/Fill-flash/Slow Sync./Rear Sync.)
AF/MF Select	Selects auto focusing or manual focusing. (Autofocus/DMF/Manual Focus)
Autofocus Area	Selects the area to be focused on. (Multi/Center/Flexible Spot)
Autofocus Mode	Selects the autofocus method. (Single-shot AF/Continuous AF)
Object Tracking	Keeps the focus on a subject while tracking it. (On/Off)
Prec. Dig. Zoom	Sets the digital zoom.
Face Detection	Detects people's faces automatically, and adjusts focus and exposure to suit the faces. (On (Regist. Faces)/On/Off)
Face Registration	Registers or changes the person to be given priority in the focus. (New Registration/Order Exchanging/Delete/Delete All)
Smile Shutter	Each time the camera detects a smile, the camera releases the shutter automatically. (On/Off)
Soft Skin Effect	Shoots the skin smoothly in the Face Detection function. (On/Off)
Shooting Tip List	Allows you to access all shooting tips.
LCD Display (DISP)	Switches the information to be displayed on the shooting screen on the LCD monitor. (Graphic Display/Display All Info./Big Font Size Disp./No Disp. Info./Histogram/For viewfinder)

Finder Display(DISP)	Switches the information to be displayed on the shooting screen on the viewfinder. (Disp. Basic Info/Histogram)
DISP Button(Monitor)	Sets the screen display modes to be displayed on the LCD monitor by pressing the DISP button.

■ Image Size

Allows you to set the image size and aspect ratio, etc.

Still	
Image Size	Selects the image size. (3:2: L:16M/ M:8.4M/ S:4.0M) (16:9: L:14M/ M:7.1M/ S:3.4M)
Aspect Ratio	Selects the aspect ratio. (3:2/16:9)
Quality	Selects the compression format. (RAW/RAW & JPEG/Fine/Standard)
3D Panorama	
Image Size	Selects the image size of 3D panoramic images. (16:9/Standard/Wide)
Panorama Direction	Selects the direction to pan the camera when shooting 3D panoramic images. (Right/Left)
Panorama	
Image Size	Selects the image size. (Standard/Wide)
Panorama Direction	Selects the direction to pan the camera when shooting panoramic images. (Right/Left/Up/Down)
Movie	
File Format	Selects AVCHD 60i/60p, AVCHD 50i/50p or MP4. (AVCHD 60i/60p/AVCHD 50i/50p/MP4)
Record Setting	Selects the image size, frame rate, and image quality of movies. (AVCHD 60i/60p/AVCHD 50i/50p: 60i/50i 24M (FX)/60i/50i 17M (FH)/60p/50p 28M (PS)/24p/25p 24M (FX)/24p/25p 17M (FH)) (MP4: 1440×1080 12M/VGA 3M)

■ Brightness/Color

Allows you to make brightness settings such as metering mode, and color settings such as white balance.

Exposure Comp.	Compensates for the brightness of the entire image. (-3.0EV to +3.0EV)
ISO	Sets the ISO sensitivity. (ISO AUTO/100 - 25600)
White Balance	Adjusts the color tones according to the ambient light conditions. (Auto WB/Daylight/Shade/Cloudy/Incandescent/ Fluor.: Warm White/Fluor.: Cool White/Fluor.: Day White/Fluor.: Daylight/Flash/C.Temp./Filter/Custom/ Custom Setup)
Metering Mode	Selects the method used for measuring the brightness. (Multi/Center/Spot)
Flash Comp.	Adjusts the amount of flash light. (-2.0EV to +2.0EV)
DRO/Auto HDR	Corrects the brightness or contrast automatically. (Off/D-Range Opt./Auto HDR)
Picture Effect	Shoots with the desired effects to express a unique atmosphere. (Off/Toy Camera/Pop Color/Posterization/Retro Photo/Soft High-key/Partial Color/High Contrast Mono./Soft Focus/HDR Painting/Rich-tone Mono./ Miniature)
Creative Style	Selects the image processing method. (Standard/Vivid/Portrait/Landscape/Sunset/Black & White)

■ Playback

Allows you to set playback functions.

Delete	Deletes images. (Multiple Img./All in Folder/All AVCHD view files)
Slide Show	Plays back images automatically. (Repeat/Interval/Image Type)
View Mode	Allows you to determine how to group the playback images. (Folder View(Still)/Folder View(MP4)/AVCHD View)

Image Index	Selects the number of images to be displayed on the index screen. (6 Images/12 Images)
Rotate	Rotates images.
Protect	Protects images, or cancels the protection. (Multiple Img./Cancel All Images/Cancel All Movies(MP4)/Cancel All AVCHD view files)
3D Viewing	Connects to a 3D compatible TV and allows you to view 3D images.
⊕ Enlarge Image	Enlarges the image.
Volume Settings	Sets the sound volume of movies.
Specify Printing	Selects the images to print, or makes printing settings. (DPOF Setup/Date Imprint)
Display Contents	Switches the information to be displayed on the playback screen. (Display Info./Histogram/No Disp. Info.)

■ Setup

Allows you to make more detailed shooting settings, or change the camera settings.

Shooting Settings	
AF Illuminator	Sets the AF illuminator to assist auto-focusing in dim places. (Auto/Off)
Red Eye Reduction	Provides pre-flash before shooting when using the flash, to prevent eyes from being shot in red. (On/Off)
FINDER/LCD Setting	Sets how to switch between an Electronic Viewfinder (sold separately) and the LCD monitor. (Auto/Manual)
Live View Display	Allows you to choose whether or not to show the value of exposure compensation, etc. on the screen display. (Setting Effect ON/Setting Effect OFF)
Auto Review	Sets the display time of the image right after shooting. (10 Sec/5 Sec/2 Sec/Off)

Grid Line	Turns on the grid line that helps you to adjust the composition of images. (Rule of 3rds Grid/Square Grid/Diag. + Square Grid/Off)
Peaking Level	Enhances the outline of in-focus ranges with a specific color. (High/Mid/Low/Off)
Peaking Color	Sets the color used for the peaking function. (White/Red/Yellow)
MF Assist	Displays an enlarged image when focusing manually. (On/Off)
MF Assist Time	Sets the length of time the image will be shown in an enlarged form. (No Limit/5 Sec/2 Sec)
Color Space	Changes the range of color reproduction. (sRGB/AdobeRGB)
SteadyShot	Sets camera shake compensation. (On/Off)
Release w/o Lens	Sets whether or not to release the shutter when there is no lens. (Enable/Disable)
Eye-Start AF	Sets whether or not to use autofocus when you look through an Electronic Viewfinder (sold separately). (On/Off)
Front Curtain Shutter	Sets whether or not to use the electronic front curtain shutter function. (On/Off)
Long Exposure NR	Sets the noise reduction processing for long exposure shootings. (On/Off)
High ISO NR	Sets the noise reduction processing for high ISO sensitivity shootings. (Normal/Low)
Lens Comp.: Shading	Compensates for the shaded corners of the screen. (Auto/Off)
Lens Comp.: Chro. Aber.	Reduces the color deviation at the corners of the screen. (Auto/Off)
Lens Comp.: Distortion	Compensates for distortion on the screen. (Auto/Off)

Movie Audio Rec	Sets the sound for movie recording. (On/Off)
Wind Noise Reduct.	Reduces wind noise during movie recording. (On/Off)
AF Micro Adj.	Finely adjusts the autofocused position, when using the LA-EA2 Mount Adaptor (sold separately). (AF Adjustment Setting/amount/Clear)
Main Settings	
Menu start	Selects a first-displayed menu from the top menu or the last menu screen. (Top/Previous)
Custom Key Settings	Assigns functions to the various keys. (Right Key Setting/Soft key B Setting/Soft key C Setting/Custom)
Touch Operation	Sets whether or not to operate the camera using the touch panel. (On/Off)
Beep	Selects the sound produced when you operate the camera. (On/Off)
 Language	Selects the language used on the screen.
Date/Time Setup	Sets the date and time.
Area Setting	Selects the area where you are using the camera.
Help Guide Display	Turns the Help Guide on or off. (On/Off)
Power Save	Sets the time to turn the camera to the power save mode. (30 Min/5 Min/1 Min/20 Sec/10 Sec)
LCD Brightness	Sets the brightness of the LCD monitor. (Auto/Manual/Sunny Weather)
Viewfinder Bright.	Sets the brightness of an Electronic Viewfinder (sold separately). (Auto/Manual)
Display Color	Selects the color of the LCD monitor. (Black/White/Blue/Pink)
Wide Image	Selects a method to display wide images. (Full Screen/Normal)
Playback Display	Selects the method used to play back portrait images. (Auto Rotate/Manual Rotate)

HDMI Resolution	Set resolution when connected to HDMI TV. (Auto/1080p/1080i)
CTRL FOR HDMI	Sets whether or not to operate the camera with a “BRAVIA” Sync-compliant TV’s Remote Control. (On/Off)
USB Connection	Selects the method used for a USB connection. (Auto/Mass Storage/MTP)
Cleaning Mode	Allows you to clean the image sensor.
Version	Displays the version of the camera and the lens.
Demo Mode	Sets whether or not to display the demonstration with movies. (On/Off)
Reset Default	Resets the camera to the factory-settings.
Memory Card Tool	
Format	Formats the memory card.
File Number	Selects the method used for assigning file numbers to images. (Series/Reset)
Folder Name	Selects the folder name format. (Standard Form/Date Form)
Select Shoot. Folder	Selects the recording folder.
New Folder	Creates a new folder.
Recover Image DB	Repairs the image database file when inconsistencies are found.
Display Card Space	Displays the remaining recording time of movies and the recordable number of still images on the memory card.
Eye-Fi Setup*	
Upload Settings	Sets the upload function of the camera when an Eye-Fi card is used. (On/Off)













- * Appears when an Eye-Fi card (sold separately) is inserted in the camera. Do not use an Eye-Fi card inserted in the camera on an airplane. If there is an Eye-Fi card inserted in the camera, set [Upload Settings] to [Off].
Eye-Fi cards can be used only in the countries/regions where they were purchased. Use Eye-Fi cards in accordance with the law of the countries/regions where you purchased the card.

Functions available for each shooting mode

The functions you can use depend on the selected shooting mode.

In the table below, ✓ indicates the function available. – indicates the function not available.

The functions you cannot use are displayed in gray on the screen.

Shoot Mode		Exposure Comp.	Self-timer	Cont. Shooting	Face Detection	Picture Effect
 (Intelligent Auto)		–	✓	✓	✓	–
 (Sweep Panorama)		✓	–	–	–	–
 (3D Sweep Panorama)		✓	–	–	–	–
 (Anti Motion Blur)		✓	–	–	✓	–
SCN (Scene Selection)		–	✓	–	✓	–
		–	✓	✓	✓	–
		–	✓	–	✓	–
		–	✓	–	✓	–
		–	✓	–	✓	–
		–	✓	–	✓	–
		–	–	–	✓	–
		–	✓	–	✓	–
P (Program Auto)		✓	✓	✓	✓	✓
A (Aperture Priority)		✓	✓	✓	✓	✓
S (Shutter Priority)		✓	✓	✓	✓	✓
M (Manual Exposure)		–	✓	✓	✓	✓

Note

- The functions available may be limited also by conditions other than the shooting mode.

Flash modes available

The flash modes you can select depend on the shooting mode and functions selected.

In the table below, ✓ indicates the function available. – indicates the function not available.

The flash modes you cannot select are displayed in gray on the screen.

Shoot Mode		Flash Off	Autoflash	Fill-flash	Slow Sync.	Rear Sync.
 (Intelligent Auto)		✓	✓	–	–	–
 (Sweep Panorama)		✓	–	–	–	–
 (3D Sweep Panorama)		✓	–	–	–	–
 (Anti Motion Blur)		✓	–	–	–	–
SCN (Scene Selection)		✓	✓	✓	–	–
		✓	–	✓	–	–
		✓	✓	✓	–	–
		✓	–	✓	–	–
		✓	–	✓	–	–
		✓	–	–	–	–
		✓	–	–	–	–
		–	–	–	✓	–
P (Program Auto)		–	–	✓	✓	✓
A (Aperture Priority)		–	–	✓	✓	✓
S (Shutter Priority)		–	–	✓	✓	✓
M (Manual Exposure)		–	–	✓	✓	✓

Notes

- The flash modes may be limited also by conditions other than the shooting mode.
- Even if you select a workable flash mode, the flash does not fire unless it is raised.
- [Autoflash] can be selected when [Shoot Mode] is set to [Intelligent Auto], or certain [Scene Selection] modes only.

Installing the software

To utilize images recorded with the camera, the following software is provided:

- “Sony Image Data Suite”
- “PMB” (Picture Motion Browser) (Windows only)

Notes

- Log on as Administrator.
- If “PMB” has already been installed on the computer, and the version number of the previously installed “PMB” is lower than that of the “PMB” on the CD-ROM (supplied), install “PMB” also from the CD-ROM (supplied).

Windows

The following computer environment is recommended when using the supplied software and importing images via a USB connection.

OS (pre-installed)	Microsoft Windows XP* SP3/Windows Vista** SP2/ Windows 7 SP1
“PMB”	CPU: Intel Pentium III 800 MHz or faster (For playing/editing the HD movies: Intel Core Duo 1.66 GHz or faster, Intel Core 2 Duo 1.66 GHz or faster, Intel Core 2 Duo 2.26 GHz or faster (HD FX/HD FH), Intel Core 2 Duo 2.40 GHz or faster (HD PS)) Memory: 512 MB or more (For playing/editing the HD movies: 1 GB or more) Hard Disk: Disk space required for installation—approximately 500 MB Display: Screen resolution—1024 × 768 dots or more
“Image Data Converter”	CPU/Memory: Pentium 4 or faster/1 GB or more Display: 1024 × 768 dots or more

* 64-bit editions and Starter (Edition) are not supported. Windows Image Mastering API (IMAPI) Ver. 2.0 or later is required to use the function for creating discs.

** Starter (Edition) is not supported.

- 1 Turn on your computer, and insert the CD-ROM (supplied) into the CD-ROM drive.
The installation menu screen appears.

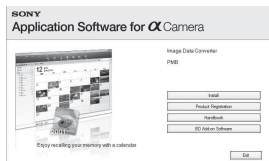

- 2 Click [Install].
 - Make sure that both “Sony Image Data Suite” and “PMB” are checked and follow the instructions on the screen.
 - Connect the camera to the computer during the procedure following the instructions on the screen.
 - When the restarting confirmation message appears, restart the computer following the instructions on the screen.
 - DirectX may be installed depending on the system environment of your computer.

- 3 Remove the CD-ROM after the installation is complete.
The software is installed and shortcut icons appear on the desktop.

Macintosh

The following computer environment is recommended when using the supplied software and importing images via a USB connection.

OS (pre-installed)	USB Connection: Mac OS X (v10.3 to v10.6) “Image Data Converter”: Mac OS X v10.5/ Mac OS X v10.6 (Snow Leopard)
“Image Data Converter”	CPU: Intel processors, such as Intel Core Solo/Core Duo/ Core 2 Duo Memory: 1 GB or more is recommended. Display: 1024 × 768 dots or more

- 1 Turn on your Macintosh computer, and insert the CD-ROM (supplied) into the CD-ROM drive.
- 2 Double-click the CD-ROM icon.

3 Copy the [IDS_INST.pkg] file in the [MAC] folder to the hard disk icon.

4 Double-click the [IDS_INST.pkg] file in the copy-to folder.

- Follow the instructions on the screen to complete the installation.

What you can do with the supplied software

■ “PMB”

With “PMB” you can do the following, etc.:

- Import images shot with the camera and display them on the computer.
- Organize images on the computer on a calendar by shooting date to view them.
- Print or save still images with the date.

For details on “PMB,” refer to “PMB Help”.

To start Help, click  (PMB Help) displayed on the desktop after installation. Or, from the start menu, click [Start] → [All Programs] → [PMB] → [PMB Help].

The support information for the “PMB” (English only):

<http://www.sony.co.jp/pmb-se/>

Note

- “PMB” is not compatible with Macintosh computers.

■ “Sony Image Data Suite”

With “Sony Image Data Suite,” you can edit images recorded in RAW format with various corrections, such as tone curve, and sharpness.

Besides, you can display and compare RAW/JPEG images recorded with this camera.

For details on “Image Data Converter,” refer to Help.

The support information for the “Sony Image Data Suite” (English only):

<http://www.sony.co.jp/ids-se/>



Creating a disc of movies

You can create a disc from AVCHD View movies that have been recorded with this camera.

Depending on the disc type, playable devices may vary.

Select the method that suits your disc player.

Here, two ways of creating a disc of movies are described; creating a disc with a computer using “PMB” or creating a disc with devices other than a computer such as a DVD writer.

Player	Disc type	Feature
Blu-ray Disc playback devices (Blu-ray Disc player, PlayStation®3, etc.)	 Blu-ray	Using a Blu-ray Disc enables you to record high-definition image quality (HD) movies of a longer duration than DVD discs.
AVCHD format playback devices (Sony Blu-ray Disc player, PlayStation®3, etc.)	 AVCHD	High-definition image quality (HD) movies can be recorded on DVD media, such as DVD-R discs, and a high-definition image quality (HD) disc is created. You cannot play a high-definition image quality (HD) disc on ordinary DVD players.
Ordinary DVD playback devices (DVD player, computer that can play DVDs, etc.)	 STD	Standard definition image quality (STD) movies converted from high-definition image quality (HD) movies can be recorded on DVD media, such as DVD-R discs, and a standard definition image quality (STD) disc is created.

■ Creating a disc using a computer

You can import AVCHD View movies to a computer using “PMB” and create an AVCHD format disc or a standard definition image quality (STD) disc. For details on the method for creating a disc using “PMB,” see “PMB Help.”

Notes







- To create a Blu-ray Disc, be sure to install [BD Add-on Software] from the “PMB” installation screen.
- The PlayStation®3 may not be available in some countries/regions.
- Movies recorded with the [60p 28M(PS)/50p 28M(PS)] setting in [Record Setting] are converted by “PMB” in order to create a disc. This conversion can take a long time. Also, you cannot create a disc with the original image quality.

- Movies recorded with the [60i 24M(FX)/50i 24M(FX)]/[24p 24M(FX)/25p 24M(FX)] setting in [Record Setting] are converted by “PMB” in order to create an AVCHD disc. This conversion can take a long time. Also, you cannot create a disc with the original image quality. If you want to keep the original image quality, you must store your movies on a Blu-ray Disc.
- “AVCHD View movies” are the movies that were recorded in the [AVCHD 60i/60p] or [AVCHD 50i/50p] mode of [File Format].

■ Creating a disc with a device other than a computer

You can create a disc with a Blu-ray Disc recorder and DVD writer.

The disc type you can create depends on the device used.

Device		Disc type
	Blu-ray Disc recorder: To create a Blu-ray Disc or DVD with standard image quality (STD)	Blu-ray STD 
	DVD writer other than DVDDirect Express: To create an AVCHD disc or DVD with standard image quality (STD)	AVCHD STD 
	HDD recorder, etc.: To create a DVD with standard image quality (STD)	STD 

Notes

- For details on how to create a disc, refer to the operating instructions of the device you use.
- If you create a disc using Sony DVDDirect (DVD Writer), use the memory card slot of the DVD Writer or connect the DVD Writer via USB connection to transfer the data.
- If you use Sony DVDDirect (DVD Writer), check that the firmware is updated to the newest version.

For details, see the following URL:

<http://sony.storagesupport.com/>

Checking the number of recordable images

Once you insert a memory card into the camera and set the power switch to ON, the number of images that can be recorded (should you continue to shoot using the current settings) is displayed on the LCD monitor.

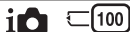

Notes

- When “0” (the number of recordable images) flashes in yellow, the memory card is full. Replace the memory card with another one, or delete images in the current memory card (page 32).
- When “NO CARD” (the number of recordable images) flashes in yellow, it means no memory card has been inserted. Insert a memory card.

■ Number of still images and time of movies that can be recorded on a memory card

Still images

The table shows the approximate number of still images that can be recorded on a memory card formatted with this camera. The values are defined using Sony standard memory cards for testing. The values may vary depending on the shooting conditions.

Image size: L 16M

Aspect ratio: 3:2*

(Units: images)

Capacity \ Quality	2GB	4GB	8GB	16GB	32GB
Standard	410	820	1650	3300	6700
Fine	290	590	1150	2400	4800
RAW & JPEG	80	155	320	640	1250
RAW	105	215	440	880	1750

* When [Aspect Ratio] is set to [16:9], you can record more images than the numbers shown in the table above (except for [RAW]).

Movies

The table below shows the approximate recording times available. These are the total times for all movie files. Continuous recording is possible for approximately 29 minutes per recording. The maximum size of an MP4 movie file is about 2 GB.

(h (hour), m (minute))

Capacity Record Setting	2GB	4GB	8GB	16GB	32GB
60i 24M(FX) 50i 24M(FX)	10 m	20 m	40 m	1 h 30 m	3 h
60i 17M(FH) 50i 17M(FH)	10 m	30 m	1 h	2 h	4 h 5 m
60p 28M(PS) 50p 28M(PS)	9 m	15 m	35 m	1 h 15 m	2 h 30 m
24p 24M(FX) 25p 24M(FX)	10 m	20 m	40 m	1 h 30 m	3 h
24p 17M(FH) 25p 17M(FH)	10 m	30 m	1 h	2 h	4 h 5 m
1440×1080 12M	20 m	40 m	1 h 20 m	2 h 45 m	5 h 30 m
VGA 3M	1 h 10 m	2 h 25 m	4 h 55 m	10 h	20 h

Note

- The recording time of movies varies because the camera is equipped with VBR (Variable Bit Rate) which automatically adjusts image quality depending on the shooting scene.

When you record a fast-moving subject, the image is clearer but the recording time is shorter because a lot of memory needed to record.

The recording time also vary depending on the shooting condition or your subject or the setting of image quality/size.

■ Number of still images that can be recorded using a battery pack

The approximate number of images that can be recorded is 430 images when you use the camera with the battery pack (supplied) at full capacity.

Note that the actual numbers may be less depending on the conditions of use.

- The number is calculated with a battery pack at full capacity and in the following situation:
 - At an ambient temperature of 25°C (77°F).
 - [Quality] is set to [Fine].
 - [Autofocus Mode] is set to [Single-shot AF].
 - Shooting once every 30 seconds.
 - The flash (HVL-F7S) strobes once every two times.
 - The power turns on and off once every ten times.
 - Using the battery pack that is charged for an hour after the CHARGE lamp goes out.
 - Using Sony “Memory Stick PRO Duo” media (sold separately).
- The measurement method is based on the CIPA standard.
(CIPA: Camera & Imaging Products Association)

List of icons on the LCD monitor

Icons are displayed on the screen to indicate the camera status.
You can change the screen display using DISP (Display Contents) on the control wheel.

Shooting standby

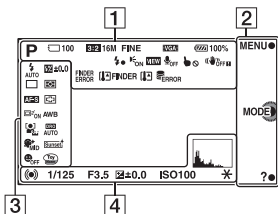

Graphic display

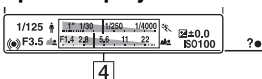

Movie recording

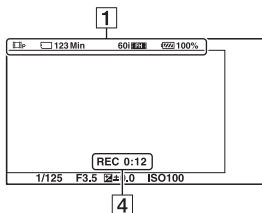



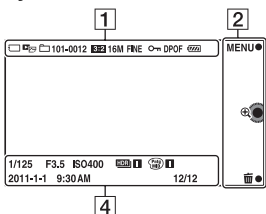



















Playback



1

Display	Indication
	Shoot Mode
	Scene Selection
	Scene Recognition
	Aspect ratio of still images
	Image size of still images
	Image quality of still images
	Number of recordable still images













Display	Indication
60i/50i FX 60i/50i FH 60p/50p PS 24p/25p FX 24p/25p FH 1080 VGA	Recording mode of movies
      	Memory card/ Upload
123Min	Recordable time of movies
 100%	Remaining battery
	Flash charge in progress
 ON	AF illuminator
VIEW	Live view
 OFF	Does not record sound during movie recording
	Touch operation off
 OFF  ON  OFF  ON	SteadyShot/ SteadyShot warning
FINDER ERROR	Electronic Viewfinder (sold separately) connection error

Display	Indication
 FINDER  FINDER	Electronic Viewfinder (sold separately) overheating warning
	Overheating warning
 FULL ERROR	Database file full/ Database file error
 MP4  AVCHD	View mode
101-0012	Playback folder – File number
	Protect
DPOF	Print order

2

Display	Indication
MENU ● MODE  ? ●	Soft keys

3



Display	Indication
 AUTO  SLOW REAR 	Flash Mode/Red Eye Reduction
    10  2  C3  C5  0.3EV  0.7EV 	Drive Mode

Display	Indication
DMF AF-S AF-C MF	Focus mode
±0.0	Flash compensation
	Metering Mode
	Focus area mode
	Object Tracking
	Face Detection
	Soft Skin Effect
AWB -1 0 +1 +2 WB 7500K A7 G7	White Balance
	DRO/Auto HDR
Std. Vivid Port. Land. Sunset B/W	Creative Style
	Picture Effect

Display	Indication
	Smile detection sensitivity indicator

4

Display	Indication
	Focus status
1/125	Shutter speed
F3.5	Aperture value
M/LM ±0.0	Metered manual
±0.0 -3, +2, +1, 0, -1, +2, +3	Exposure compensation
ISO400	ISO sensitivity
	AE lock
	Shutter speed indicator
	Aperture indicator
REC 0:12	Recording time of the movie (m:s)
2011-1-1 9:30AM	Recorded date/time of the image
12/12	Image number/ Number of images in the view mode
HDR	Appears when HDR did not work on the image.

Display	Indication
	Appears when Picture Effect did not work on the image.
	Histogram

Learning more about the camera (α Handbook)

“ α Handbook,” which explains how to use the camera in detail, is included on the CD-ROM (supplied). Refer to it for in-depth instructions on the many functions of the camera.

■ For Windows users

- 1 Turn on your computer, and insert the CD-ROM (supplied) into the CD-ROM drive.
 - 2 Click [Handbook].
 - 3 Click [Install].
 - 4 Start “ α Handbook” from the shortcut on the desktop.
-

■ For Macintosh users

- 1 Turn on your computer, and insert the CD-ROM (supplied) into the CD-ROM drive.
 - 2 Select the [Handbook] folder and copy “Handbook.pdf” stored in the [GB] folder to your computer.
 - 3 After copying is complete, double-click “Handbook.pdf.”
-

Troubleshooting

If you experience trouble with the camera, try the following solutions.

- 1 Check the items on pages 78 to 81. Also refer to “ α Handbook” (PDF).**
- 2 Remove the battery pack, wait for about one minute, re-insert the battery pack, then turn on the power.**
- 3 Reset the settings (page 62).**
- 4 Consult your Sony dealer or local authorized Sony service facility.**

Battery pack and power

The battery pack cannot be installed.

- When you insert the battery pack, use the tip of the battery pack to push the lock lever (page 17).
- You can use an NP-FW50 battery pack only. Make sure that the battery is NP-FW50.

The remaining battery indicator is incorrect, or sufficient remaining battery indicator is displayed but the power runs out too quickly.

- This phenomenon occurs when you use the camera in an extremely hot or cold location.
- The battery pack is discharged. Install a charged battery pack (page 15).
- The battery pack is dead. Replace it with a new one.

Cannot turn on the camera.

- Install the battery pack correctly (page 17).
- The battery pack is discharged. Install a charged battery pack (page 15).
- The battery pack is dead. Replace it with a new one.

The power turns off suddenly.

- When the camera or battery pack is too warm, the camera displays a warning message and turns off automatically to protect the camera.

- If you do not operate the camera for given period of time, the camera turns to power saving mode. To cancel the power save, operate the camera, such as pressing the shutter button halfway down.

The CHARGE lamp flashes when charging the battery pack.

- You can use an NP-FW50 battery pack only. Make sure that the battery is NP-FW50.
- If you charge a battery pack that has not been used for a long time, the CHARGE lamp may flash.
- The CHARGE lamp flashes in two ways, fast (about 0.15-second intervals) and slow (about 1.5-second intervals). If it is flashing fast, remove the battery pack and reattach the same battery pack securely. If the CHARGE lamp flashes fast again, it suggests that there is something wrong with the battery pack. Slow flashing indicates that charging is suspended because the ambient temperature is outside the suitable range for charging the battery pack. Charging will resume and the CHARGE lamp will be lit when the ambient temperature returns to within the suitable temperature. Charge the battery pack under the suitable temperatures between 10 °C and 30 °C (50 °F and 86 °F).

Shooting images

Nothing is displayed on the LCD monitor when the power is turned on.

- If you do not operate the camera for given period of time, the camera turns to power saving mode. To cancel the power save, operate the camera, such as pressing the shutter button halfway down.

The shutter does not release.

- You are using a memory card with a write-protect switch, and the switch is set to the LOCK position. Set the switch to the recording position.
- Check the free capacity of the memory card.
- You cannot record images while charging the flash.
- The lens is not attached properly. Attach the lens properly (page 19).

Recording takes a long time.

- The noise reduction function is turned on. This is not a malfunction.
- You are shooting in the RAW mode. Since the RAW data file is large, the RAW mode shooting may take time.
- The Auto HDR is processing an image.

The image is out of focus.

- The subject is too close. Check the minimum focal distance of the lens.

- You are shooting in manual focus mode. Set [AF/MF Select] to [Autofocus].
 - Ambient light is insufficient.
 - The subject may require special focusing. Use the [Flexible Spot] or manual focus function.
-

The flash does not work.

- Raise the flash (page 23).
 - The flash is not attached correctly. Reattach the flash (page 23).
 - You cannot use a flash with the following shooting mode:
 - [Bracket: Cont.]
 - [Sweep Panorama]
 - [3D Sweep Panorama]
 - [Night Scene] and [Hand-held Twilight] in [Scene Selection]
 - [Anti Motion Blur]
 - Movie recording
-

Fuzzy white circular spots appear on images shot using the flash.

- Particles (dust, pollen, etc.) in the air reflected the flash light and appeared on the image. This is not a malfunction.
-

The flash takes too long to recharge.

- The flash has been fired in succession in a short period. When the flash has been fired in succession, the recharging process may take longer than usual to avoid overheating of the flash.
-

The image taken with the flash is too dark.

- If the subject is beyond the flash range (the distance that the flash can reach), the pictures will be dark because the flash light does not reach the subject. If the ISO is changed, the flash range also changes with it (page 49).
-

The date and time are recorded incorrectly.

- Set the correct date and time (page 25).
 - The area selected with [Area Setting] is different from the actual area. Set the actual area by selecting MENU → [Setup] → [Area Setting].
-

The aperture value and/or shutter speed flashes when you press the shutter button halfway down.

- Since the subject is too bright or too dark, it is beyond the available range of the camera. Adjust the setting again.

The image is whitish (Flare).**Blurring of light appears on the image (Ghosting).**

- The picture was taken under a strong light source, and excessive light has entered the lens. When using the zoom lens, attach a lens hood.

The corners of the picture are too dark.

- If any filter or hood is used, take it off and try shooting again. Depending on the thickness of the filter and improper attachment of the hood, the filter or the hood may partially appear on the image. The optical properties of some lenses may cause the periphery of the image to appear too dark (insufficient light). You may compensate for this phenomenon with [Lens Comp.: Shading].

The eyes of the subject come out red.

- Activate the Red Eye Reduction function.
- Get close to the subject, and shoot the subject within the flash range (page 49) using the flash.

Dots appear and remain on the LCD monitor.

- This is not a malfunction. These dots are not recorded (page 82).

The image is blurred.

- The picture was taken in a dark location without the flash, resulting in camera shake. The use of a tripod or the flash is recommended (page 23). [Hand-held Twilight] in [Scene Selection] (page 45) and [Anti Motion Blur] (page 45) are also effective in reducing blur.

The exposure value is flashing on the LCD monitor.

- The subject is too bright or too dark for the metering range of the camera.

Viewing images

Images cannot be played back.

- The folder/file name has been changed on your computer.
- When an image file has been processed by a computer or when the image file was recorded using a model other than that of your camera, playback on your camera is not guaranteed.
- The camera is in USB mode. Delete the USB connection.

Precautions

On the functions available with the camera

- Your camera is 1080 60i-compatible or 1080 50i-compatible.
To check whether the camera is 1080 60i-compatible or 1080 50i-compatible, check for the following marks on the bottom of the camera.
1080 60i-compatible camera: 60i
1080 50i-compatible camera: 50i
- This camera can record 1080 60p/50p mode movies. Unlike conventional movies that are recorded with an interlace scanning system, 1080 60p/50p movies are recorded with a progressive scanning system. Using a progressive scanning system method increases the resolution and allows you to record smoother and more realistic movies.
- You may feel uncomfortable symptoms such as eyestrain, nausea, or a tired feeling while watching 3D images recorded with the camera on 3D compatible monitors. When you watch 3D images, we recommend that you take a break at regular time intervals. Since the need for or frequency of break times varies between individuals, please set your own standards. If you feel sick, stop watching 3D images, and consult a doctor as needed. Also, refer to the operating instructions of the connected device or the

software used with the camera. A child's vision is always vulnerable (especially for children under six years of age). Before allowing them to watch 3D images, please consult with an expert, such as a pediatric or ophthalmic doctor. Make sure your children follow the precautions above.

On the LCD monitor and lens

- The LCD monitor is manufactured using extremely high-precision technology so over 99.99 % of the pixels are operational for effective use. However, there may be some tiny black points and/or bright points (white, red, blue or green in color) that constantly appear on the LCD monitor. These points are normal in the manufacturing process and do not affect the images in any way.

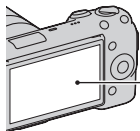

Black, white, red, blue and green points

- Do not hold the camera by taking hold of the LCD monitor.
- A magnet is attached to the back of the LCD monitor. Do not put objects that are affected by magnetic fields, such as a floppy disk or a credit card, between the LCD monitor and the camera body.

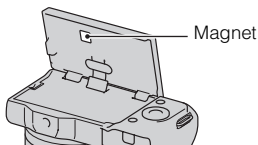

- Images may trail across on the LCD monitor in a cold location. This is not a malfunction. When turning on the camera in a cold location, the LCD monitor may become temporarily dark.
- Do not press against the LCD monitor. The monitor may be discolored and that may cause a malfunction.
- Do not expose the camera to direct sunlight. If sunlight is focused on a nearby object, it may cause a fire. When you must place the camera under direct sunlight, attach the front lens cap.

On using the lenses and accessories

It is recommended that you use Sony lenses/accessories designed to suit the characteristics of this camera. Using the products of other manufacturers may cause the camera not to operate to its capability, or result in accidents and malfunctions of the camera.

On the Smart Accessory Terminal 2

Set the power switch of the camera to OFF before you attach or remove an accessory, such as the flash, to the Smart Accessory Terminal 2. When attaching an accessory, plug the accessory into the Smart Accessory

Terminal 2 to the end and fasten the screw. Make sure that the accessory is attached to the camera securely.

Do not use/store the camera in the following places

- In an extremely hot, dry or humid place
In places such as in a car parked in the sun, the camera body may become deformed and this may cause a malfunction.
- Storing under direct sunlight or near a heater
The camera body may become discolored or deformed, and this may cause a malfunction.
- In a location subject to rocking vibration
- Near strong magnetic place
- In sandy or dusty places
Be careful not to let sand or dust get into the camera. This may cause the camera to malfunction, and in some cases this malfunction cannot be repaired.

On the grip

The grip is applied with a special coating. It may be discolored if it is rubbed with dark colored cloth, leather, etc.

On storing

Be sure to attach the front lens cap when not using the camera.

On the temperature of the camera

Your camera and battery may get hot due to continuous use, but it is not a malfunction.

On operating temperatures

Your camera is designed for use under the temperatures between 0°C and 40°C (32°F and 104°F).

Shooting in extremely cold or hot places that exceed this range is not recommended.

On moisture condensation

If the camera is brought directly from a cold to a warm location, moisture may condense inside or outside the camera. This moisture condensation may cause a malfunction of the camera.

How to prevent moisture condensation

When bringing the camera from a cold place to a warm place, seal the camera in a plastic bag and allow it to adapt to conditions at the new location over about an hour.

If moisture condensation occurs

Turn off the camera and wait about an hour for the moisture to evaporate. Note that if you attempt to shoot with moisture remaining inside the lens, you will be unable to record clear images.

On the internal rechargeable battery

This camera has an internal rechargeable battery for maintaining the date and time and other settings regardless of whether the power is on or off, or the battery is installed or not. This rechargeable battery is continually charged as long as you are using the camera. However, if you use the camera for only short periods, it discharges gradually, and

if you do not use the camera at all for about three months it becomes completely discharged. In this case, be sure to charge this rechargeable battery before using the camera.

However, even if this rechargeable battery is not charged, you can still use the camera as long as you do not record the date and time. If the camera resets the settings to the defaults each time you charge the battery, the internal rechargeable battery may be dead. Consult your Sony dealer or local authorized Sony service facility.

Charging method of the internal rechargeable battery

Insert a charged battery pack into the camera, or connect the camera to a wall outlet (wall socket) using the AC Adaptor (sold separately), and leave the camera for 24 hours or more with the power off.

On memory cards

Do not attach a label, etc. on a memory card or a card adaptor. This may cause a malfunction.

On recording/playback

- When you use a memory card with this camera for the first time, it is recommended to format the card using the camera for stable performance of the memory card before shooting. Note that formatting permanently erases all data on the memory card, and is unrecoverable. Save precious data on a computer, etc.
- If you repeatedly record/delete images, fragmentation of data may occur on the memory card. Movies

may not be able to be saved or recorded. In such a case, save your images to a computer or other storage location, then format the memory card.

- The recorded contents cannot be compensated for even if recording or playback is not possible due to a malfunction of the camera or memory card, etc.
- To avoid the potential risk of data loss, always copy (back up) data to other medium.
- Before you record one-time events, make a trial recording to make sure that the camera is working correctly.
- This camera is neither dust-proof, nor splash-proof, nor water-proof.
- Do not aim the camera at the sun or other bright light. It may cause the malfunction of the camera.
- Do not look at the sun or a strong light through a removed lens. This may cause irrecoverable damage to your eyes. Or it may cause a malfunction of the lens.
- Do not use the camera near a location that generates strong radio waves or emits radiation. The camera may not be able to record or play back properly.
- Using the camera in sandy or dusty locations may cause malfunctions.
- If moisture condensation occurs, remove it before using the camera (page 84).
- Do not shake or strike the camera. In addition to malfunctions and an inability to record images, this may render the memory card unusable,

or cause image data breakdown, damage or loss.

- Clean the flash surface with a soft cloth. The heat of flash emission may cause dirt to adhere on the flash surface, resulting in smoking or scorching.
- Keep the camera, supplied accessories, etc., out of the reach of children. A memory card, etc., may be swallowed. If such problem occurs, consult a doctor immediately.

On RAW images

To view RAW images recorded with the camera, “Image Data Converter” on the CD-ROM (supplied) is required. If you do not intend to modify the images you record, we recommend that you shoot images using the JPEG format.

Notes when playing movies on other devices

- This camera uses MPEG-4 AVC/H.264 High Profile for AVCHD format recording. Movies recorded in AVCHD format with this camera cannot be played by the following devices.
 - Other devices compatible with AVCHD format that does not support High Profile
 - Devices incompatible with the AVCHD format
- This camera also uses MPEG-4 AVC/H.264 Main Profile for MP4 format recording. For this reason, movies recorded in MP4 format with this camera cannot be played on devices other than those that support MPEG-4 AVC/H.264.

- Discs recorded with HD (high definition) image quality can be played back only on AVCHD format-compatible devices. DVD-based players or recorders cannot play back HD image quality discs, as they are incompatible with the AVCHD format. Also, DVD-based players or recorders may fail to eject HD image quality discs.
- 1080 60p/50p movies can be played back on compatible devices only.

Warning on copyright

Television programs, films, videotapes, and other materials may be copyrighted. Unauthorized recording of such materials may be contrary to the provisions of the copyright laws.

The pictures used in this manual

The photographs used as examples of pictures in this manual are reproduced images, and are not actual images shot using this camera.

On the data specifications described in this manual

The data on performance and specifications is defined under the following conditions, except as described in this manual: at an ordinary ambient temperature of 25°C (77°F), and using a battery pack that is charged for an hour after the CHARGE lamp goes out.

Specifications

Camera

[System]

Camera type: Interchangeable lens digital camera

Lens: E-mount lens

[Image sensor]

Image sensor: 23.5 × 15.6 mm (APS-C format) CMOS image sensor

Total pixel number of image sensor:
Approx. 16 700 000 pixels

Effective pixel number of camera:
Approx. 16 100 000 pixels

[Anti-dust]

System: Charge protection coating on Low-Pass Filter and ultrasonic vibration mechanism

[Auto focus system]

System: Contrast detection system
Sensitivity range: EV0 to EV20 (at ISO 100 equivalent, with F2.8 lens)

[Exposure control]

Metering method: 1 200-segment metering by the image sensor
Metering range: EV0 to EV20 (at ISO 100 equivalent, with F2.8 lens)
ISO sensitivity (Recommended exposure index): Auto, ISO 100 to 25600
Exposure compensation: ±3.0 EV (1/3 EV step)

[Shutter]

Type: Electronically-controlled, vertical-traverse, focal-plane type
Speed range: 1/4000 second to 30 seconds, BULB, (1/3 EV step)
Flash sync speed: 1/160 second

[Recording media]

“Memory Stick PRO Duo” media, SD card

[LCD monitor]

LCD panel: 7.5 cm (3.0 type) TFT drive
Total number of dots: 921 600 (640 × 3 (RGB) × 480) dots

[Input/output terminals]

USB: miniB
HDMI: HDMI type C minijack

[Power]

Used battery pack: Rechargeable battery pack NP-FW50

[Others]

Exif Print: Compatible
PRINT Image Matching III: Compatible
Dimensions (CIPA compliant):
Approx. 110.8 × 58.8 × 38.2 mm
(4 3/8 × 2 3/8 × 1 9/16 inches)
(W/H/D)
Mass (CIPA compliant):
Approx. 269 g (9.5 oz)
(including battery and “Memory Stick PRO Duo” media)
Approx. 210 g (7.4 oz)
(camera only)
Operating temperature: 0°C to 40°C
(32°F to 104°F)
File format:
Still image: JPEG (DCF Ver. 2.0, Exif Ver. 2.3, MPF Baseline) compliant, DPOF compatible
3D still images: MPO (MPF Extended (Disparity Image)) compliant
Movie (AVCHD View):
AVCHD format (1080 60p or 1080 50p, original format)

Video: MPEG-4 AVC/H.264
Audio: Dolby Digital 2ch
Dolby Digital Stereo Creator

- Manufactured under license from Dolby Laboratories.

Movie (MP4 View): MP4 format
Video: MPEG-4 AVC/H.264
Audio: MPEG-4 AAC-LC 2ch

USB communication: Hi-Speed USB
(USB 2.0)

Capacity: Typical 7.7 Wh (1 080 mAh)
Minimum 7.3 Wh (1 020 mAh)

Maximum dimensions:
Approx. 31.8 × 18.5 × 45 mm
(1 5/16 × 3/4 × 1 13/16 inches)
(W/H/D)

Mass: Approx. 57 g (2.1 oz)

Flash HVL-F7S

Flash guide number: GN 7 (in meters at ISO 100)

Recycling time: Approx. 4 seconds

Flash coverage: Covering 16 mm lens
(focal length that the lens indicates)

Flash compensation: ±2.0 EV (1/3 EV step)

Dimensions (CIPA compliant):

Approx. 35.9 × 23.8 × 42.7 mm
(1 7/16 × 15/16 × 1 11/16 inches)
(W/H/D)

Mass: Approx. 20.4 g (0.8 oz)

Battery charger BC-VW1

Input rating: 100 V – 240 V AC,
50 Hz/60 Hz, 4.2 W

Output rating: 8.4 V DC, 0.28 A

Operating temperature range: 0°C to 40°C (32° to 104°F)

Storage temperature range: –20°C to +60°C (–4°F to +140°F)

Maximum dimensions: Approx. 63 × 95 × 32 mm (2 1/2 × 3 3/4 × 1 5/16 inches) (W/H/D)

Mass: Approx. 85 g (3 oz)

Rechargeable battery pack NP-FW50

Used battery: Lithium-ion battery

Maximum voltage: DC 8.4 V

Nominal voltage: DC 7.2 V

Maximum charge voltage: DC 8.4 V

Maximum charge current: 1.02 A

Lens

Lens	E16 mm single focus lens	E18 – 55 mm zoom lens	E55 – 210 mm zoom lens
Camera	NEX-5ND	NEX-5ND/5NK/ 5NY	NEX-5NY
Equivalent 35 mm-format focal length ¹⁾ (mm)	24	27 - 82.5	82.5 - 315
Lens groups-elements	5-5	9-11	9-13
Angle of view ¹⁾	83°	76° - 29°	28.2° - 7.8°
Minimum focus ²⁾ (m (feet))	0.24 (0.79)	0.25 (0.82)	1.0 (3.28)
Maximum magnification (x)	0.078	0.3	0.225
Minimum f-stop	f/22	f/22 - f/32	f/22 - f/32
Filter diameter (mm)	49	49	49
Dimensions (max. diameter × height) (mm (in.))	62.0 × 22.5 (2 1/2 × 29/32)	62.0 × 60.0 (2 1/2 × 2 3/8)	63.8 × 108 (2 5/8 × 4 3/8)
Mass (g (oz.))	67 (2.4)	194 (6.8)	345 (12.2)
Compensation effect ³⁾	– ⁴⁾	Approx. 4 steps	Approx. 4 steps

1) The values for equivalent 35 mm-format focal length and angle of view are based on digital cameras equipped with an APS-C sized image sensor.

2) Minimum focus is the shortest distance from the image sensor to the subject.

3) Shutter speed (differs with shooting conditions)

4) The optical shake compensation function is not available.

Design and specifications are subject to change without notice.

On focal length

The picture angle of this camera is narrower than that of a 35 mm-format film camera. You can find the approximate equivalent of the focal length of a 35 mm-format film camera, and shoot with the same picture angle, by increasing the focal length of your lens by half.

For example, by using a 50 mm lens, you can get the approximate equivalent of a 75 mm lens of a 35 mm-format film camera.

On image data compatibility

- This camera conforms with DCF (Design rule for Camera File system) universal standard established by JEITA (Japan Electronics and Information Technology Industries Association).
- Playback of images recorded with your camera on other equipment and playback of images recorded or edited with other equipment on your camera are not guaranteed.

Trademarks

- **α** is a trademark of Sony Corporation.
- “Memory Stick,”  “Memory Stick PRO,” **MEMORY STICK PRO**, “Memory Stick Duo,” **MEMORY STICK DUO**, “Memory Stick PRO Duo,” **MEMORY STICK PRO DUO**, “Memory Stick PRO-HG Duo,” **MEMORY STICK PRO-HG DUO**, “Memory Stick Micro,” “MagicGate,” and **MAGICGATE** are trademarks of Sony Corporation.
- “InfoLITHIUM” is a trademark of Sony Corporation.

- “PhotoTV HD” is a trademark of Sony Corporation.
- DVDirect is a trademark of Sony Corporation.
- Blu-ray Disc™ and Blu-ray™ are trademarks of the Blu-ray Disc Association.
- “AVCHD” and “AVCHD” logotype are trademarks of Panasonic Corporation and Sony Corporation.
- Dolby and the double-D symbol are trademarks of Dolby Laboratories.
- Microsoft, Windows, and Windows Vista are either registered trademarks or trademarks of Microsoft Corporation in the United States and/or other countries.
- HDMI, the HDMI logo and High-Definition Multimedia Interface are trademarks or registered trademarks of HDMI Licensing LLC.
- Macintosh and Mac OS are trademarks or registered trademarks of Apple Inc.
- PowerPC is a registered trademark of IBM Corporation in the United States.
- Intel, Intel Core, and Pentium are trademarks or registered trademarks of Intel Corporation.
- SDXC logo is trademarks of SD-3C, LLC.
- Eye-Fi is a trademark of Eye-Fi Inc.
- MultiMediaCard is a trademark of MultiMediaCard Association.
-  and “PlayStation” are registered trademarks of Sony Computer Entertainment Inc.
- Adobe is a registered trademark or a trademark of Adobe Systems Incorporated in the United States and/or other countries.
- In addition, system and product names used in this manual are, in general, trademarks or registered

trademarks of their respective developers or manufacturers. However, the ™ or ® marks are not used in all cases in this manual.



- Add further enjoyment with your PlayStation 3 by downloading the application for PlayStation 3 from PlayStation Store (where available.)
- The application for PlayStation 3 requires PlayStation Network account and application download. Accessible in areas where the PlayStation Store is available.



Index

Numerics

3D Sweep Panorama.....	46
3D Viewing.....	54

A

AF Illuminator	59
AF Micro Adj.	61
AF/MF Select.....	56
Anti Motion Blur	45
Aperture Priority.....	47
Area Setting	61
Aspect Ratio.....	57
Auto Review	59
Autofocus Area.....	56
Autofocus Mode	56

B

Background Defocus Control	39
Battery pack	15
Beep	61

C

Charging time	15
Cleaning Mode.....	62
Color Space.....	60
Computer	65
Cont. Shooting	42
Control wheel.....	33
Creating a disc of movies	68
Creative Style.....	58
CTRL FOR HDMI.....	62
Custom Key Settings	61

D

Date/Time Setup	61
Delete	32
Demo Mode	62
DISP Button(Monitor)	57
Display Card Space.....	62
Display Color.....	61

Display Contents	43
Drive Mode	56
DRO/Auto HDR.....	58
DVD	69

E

Enlarge	52
Enlarge Image	52
Exposure compensation	41
Eye-Fi Setup.....	62
Eye-Start AF.....	60

F

Face Detection.....	56
Face Registration.....	56
File Format	57
File Number	62
Fill-flash	48
Finder Display(DISP).....	57
FINDER/LCD Setting	59
Flash	23
Flash Comp.	58
Flash Mode.....	48
Folder Name.....	62
Format	62
Front Curtain Shutter.....	60

G

Grid Line	60
-----------------	----

H

Handbook	77
Hand-held Twilight	45
HDMI Resolution.....	62
Help Guide Display	61
Help Guides.....	37
High ISO NR.....	60

I

Icons	73
-------------	----

Image Index	53
Image Size	49
Install	65
Intelligent Auto	44
ISO	58

L

Landscape	45
Language.....	61
LCD Brightness	61
LCD Display (DISP).....	56
Lens.....	19
Lens Comp.: Chro. Aber.....	60
Lens Comp.: Distortion	60
Lens Comp.: Shading.....	60
Live View Display	59
Long Exposure NR	60

M

Macintosh	66
Macro	45
Manual Exposure	44
Memory card.....	21
Menu	55
Menu start	61
Metering Mode	58
MF Assist.....	60
MF Assist Time	60
Moisture condensation.....	84
Movie.....	29
Movie Audio Rec.....	61

N

New Folder	62
Night Portrait	45
Night Scene.....	45

O

Object Tracking	56
-----------------------	----

P

Panorama	46
Panorama Direction	57

Peaking Color.....	60
Peaking Level.....	60
Photo Creativity	38
Picture Effect.....	40, 58
Playback	30
Playback Display.....	61
Playback on TV.....	54
Playback zoom	52
PMB	67
Portrait.....	45
Power Save.....	61
Prec. Dig. Zoom	56
Program Auto	44
Protect	59

Q

Quality.....	57
--------------	----

R

Record Setting	57
Recover Image DB.....	62
Red Eye Reduction.....	59
Release w/o Lens.....	60
Reset Default.....	62
Rotate	59

S

Scene Selection	45
Scroll playback.....	46
Select Shoot. Folder	62
Self-timer.....	41
Self-timer(Cont)	42
Setting the clock.....	25
Setup.....	59
Shoot Mode	44
Shooting still images	27
Shooting Tip List.....	56
Shooting tips.....	37
Shutter Priority	47
Slide Show	58
Smile Shutter.....	56
Soft keys.....	34

Soft Skin Effect.....	56
Software.....	65
Sony Image Data Suite	67
Spd Priority Cont.	43
Specifications.....	87
Specify Printing	59
Sports Action	45
SteadyShot	60
Sunset.....	45
Sweep Panorama.....	46

T

Touch Operation	61
-----------------------	----

U

Upload Settings.....	62
USB Connection	62

V

Version.....	62
View Mode	58
Viewfinder Bright.....	61
Volume Settings.....	59

W

White Balance.....	58
Wide Image.....	61
Wind Noise Reduct.....	61
Windows	65